

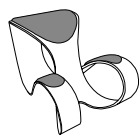

Lounge Collection



Design Chairs Index



MOON

04 | 19



CITY

20 | 31



CITY DÉCO

32 | 37



COMPASSO

38 | 47



CODE

48 | 59



COVE

60 | 71



CLUE

72 | 81



CELSIUS

82 | 89



CLARK

90 | 97



C-STOOL

98 | 103



CELL

104 | 113



CLOSE

114 | 123

Soft Seating Index

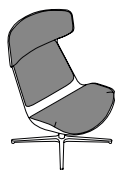

CLEOPAS

124 | 137



CITY
LOUNGE

138 | 151



CITY DÉCO
LOUNGE

152 | 157

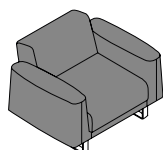

AVANA

158 | 171

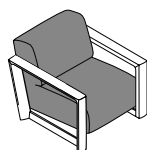

ARCO

172 | 181

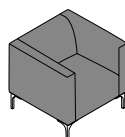

ARTE

182 | 191

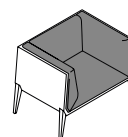

ACCORD

192 | 203

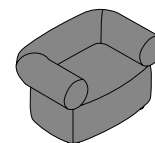

ABBEY

204 | 213

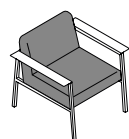

ADO

214 | 225



ASTRO

226 | 237

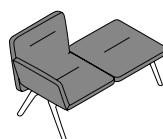

ARMONY

238 | 247



AGIO

248 | 255

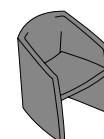

ALIAS

256 | 261



designed by Serena Papait

**Copernican revolution.
Moon redesigns the
concept of ergonomics:
a unique and continuous
structure that moulds
the body into a more
natural posture.**

**Rivoluzione copernicana.
Moon riscrive il concetto di ergonomia: una
struttura unica e continua che plasma il corpo in
una postura più naturale.**



MOON design chair | White polypropylene shell and E01/421 fabric upholstered soft pads
FLIPPER home office table | White frame and top

Residential & Hospitality Collection



From pencil to space: Moon is the result of research on paper which culminates in a unique piece, designed to adapt to people of all ages.

Dalla matita allo spazio: Moon è frutto di una ricerca condotta su carta, che trova compimento nel design di un pezzo unico, progettato per adattarsi a persone di tutte le età.



MOON design chair | Umbra Grey polypropylene shell and E01/431 fabric upholstered soft pads

Residential & Hospitality Collection





In Moon, the colours of the shell and soft pads are customisable to suite tastes and settings. The seat becomes a furnishing piece for the home office and other professional settings.

I colori della scocca e dei cuscinetti di Moon sono personalizzabili a seconda dei gusti e del contesto di destinazione. La seduta diventa un oggetto d'arredo per l'home office e altri ambienti professionali.



MOON design chair | Umbra Grey polypropylene shell and E01/431 fabric upholstered soft pads
P1 BOISERIE | Whitened Elm panels and shelves, Umbra Grey tracks
FIVE table | Umbra Grey legs and Whitened Elm top





The neoprene soft pads are non-deformable and boost comfort, acting as decompression points. They are covered in fabric and available in different colours, including vibrant tonalities that match the shell, or elegant hues according to taste preferences.

I cuscini in neoprene sono indeformabili e aumentano il comfort, diventando dei punti di decompressione. Sono rivestiti in tessuto, disponibile in diverse tonalità, per creare abbinamenti con la scocca vivaci o eleganti in base ai propri gusti.



MOON design chair | Olive Green polypropylene shell and E01/417 fabric upholstered soft pads
HALF MOON table lamp | Black fabric shade and Black base



The seat is designed to distribute the weight on the knees in particular, without weighing down the spine.

This is also possible thanks to a perpetual oscillation movement of the body, induced by sitting.

La seduta è concepita per distribuire il peso in particolare sulle ginocchia, senza andare ad appesantire la colonna vertebrale. Questo è possibile anche grazie a un movimento perpetuo di oscillazione del corpo, indotto dalla seduta.







Elegance, presence and dynamism: Moon is not only a seat designed in the name of ergonomics and postural well-being, but it's also a piece of furniture with a refined design.

Eleganza, presenza e dinamicità: Moon non è solo una seduta progettata all'insegna dell'ergonomia e del benessere posturale, ma è anche un oggetto d'arredo dal design ricercato.





MOON design chair | White polypropylene shell and E01/429 fabric upholstered soft pads
LIBRERIA bookshelves | Ocean Blue lacquer
X1 desk | White legs and top



designed by Edi & Paolo Ciani

**Balanced design.
When aesthetics and
comfort meet, it brings
City to life: harmonious
shapes and finishings,
for a versatile and
ergonomic seat.**

**Equilibri di design.
Quando estetica e comfort si incontrano,
nasce City: forme e finiture in armonia, per
una seduta versatile ed ergonomica.**







CITY design chair | P01/095 leather and Umbra Grey frame
NINE table | Ebony top and Umbra Grey legs
BLONDE pendant lamp | Gold

Residential & Hospitality Collection



Every single detail of City is meticulously pondered: double stitching, different upholstery densities, back inclinations, streamlined thicknesses and soft bossing. All this so that the seat can be enjoyed in superlative comfort.

Ogni particolare di City è curato: cuciture con doppia battitura, densità diverse dell'imbottitura, inclinazione dello schienale, spessori sottili e bombature morbide. Tutto per godersi la seduta con la massima comodità.





CITY design chair | D02/272 fabric and Chrome frame
CITY design chair | B03/180 simil leather and Chrome frame
T45 desk | Elm top and frame









CITY design chair | E03/467 fabric and Oak varnished solid ash wood legs
THREE table | Umbra Grey lacquer top, Oak and Umbra Grey legs

City is suitable for all settings and styles, thanks to the vast assortment of finishes and frames. The version with four wooden legs is a timeless classic, evoking natural elements and a nordic ambience.

City è adatta ad ogni ambiente e stile grazie alla vasta disponibilità di rivestimenti e basamenti. La versione con quattro gambe in legno è un classico intramontabile, che evoca elementi naturali e atmosfere nordiche.





CITY DÉCO

designed by Edi & Paolo Ciani

**Bohémian spirit.
City Déco is a variant of the
collection City. Welcoming
and elegant, thanks to
a particular artisanal
technique, a rich and draped
effect is created on the seat.**

Spirito bohémien.

**City Déco è una variante della collezione City.
Accogliente ed elegante, grazie ad una
particolare lavorazione del tessuto viene creato
un effetto ricco e drappeggiato sulla seduta.**





The special finish and artisan stitching of the fabric create a drapery effect, enriching the seat with an original and alluring appearance, matched with wood or metal legs.

La lavorazione particolare e la cucitura artigianale del tessuto creano un effetto drappeggiato, che conferisce alla seduta un aspetto ricercato e seducente, con la complicità delle gambe in legno o in metallo.



CITY DÉCO design chair | D03/368 fabric and Oak varnished solid ash wood legs
NINE table | Elm top and Matt White legs







COMPASSO

designed by Dorigo Design

**Artistic geometries.
Compasso is an ash wood
sculpture that exudes
originality and refinement
in both its design and build,
matched with a pureness
laden with meaning.**

**Geometrie d'arte.
Compasso è una scultura in legno di frassino, ricercata
e sofisticata dalla progettazione alla realizzazione,
con una purezza ricca di significato.**







COMPASSO design chair | Umbra Grey varnished solid ash wood frame and B03/185 simil leather seat
T06 round table | Eucalyptus top and Umbra Grey frame
FIVE table | Eucalyptus top and Umbra Grey frame



The name is inspired by the angle formed by the cantilevered joint on the rear of the back. The legs are triangular on the lower part and square on the upper part, which adds an original touch to all interiors.

Il nome deriva dall'angolo formato dal raccordo a sbalzo sul retro dello schienale. Le gambe sono triangolari nella parte inferiore e quadrate in quella superiore, per conferire un tocco ricercato ad ogni ambiente.



COMPASSO design chair | Oak varnished solid ash wood frame and Umbra Grey varnished solid ash wood seat and back
COZY coffee table | Oak top and Umbra Grey frame





The variable section plywood back and seat are available in different finishings: oak ash, walnut, umbra grey and white. The seat can also be upholstered and covered with many kinds of fabric options for different interiors.

Lo schienale è in legno multistrato a sezione variabile e il sedile è stato pensato in svariate finiture: frassino tinta rovere, noce, grigio ombra e bianco. Il sedile si può imbottire e rivestire con numerosi tipi di tessuti per arredare diversi tipi di spazi.



COMPASSO design chair | Walnut varnished solid ash wood frame and E04/475 fabric seat
FIVE table | Canaletto Walnut top and Umbra Grey frame
BLOOM credenza | Nero Greco porcelain stoneware and Umbra Grey legs
ADD pendant lamp | Matt clay shade



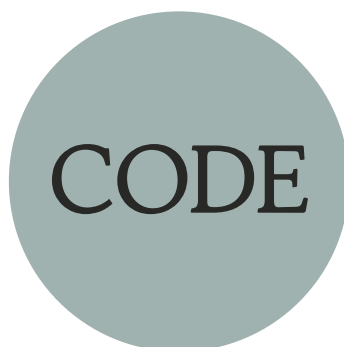

designed by Dorigo Design

**Cutting-edge comfort.
Technique and
ergonomics go hand
in hand in the shape of
Code, bringing to life a
mindful and gracefully
inviting seat.**

**Comfort d'avanguardia.
Tecnica ed ergonomia si intrecciano nelle
forme di Code, per dare vita a una seduta
sapiente che accoglie con garbo.**



CODE design chair | Walnut varnished solid ash wood legs and shell, C05/280 fabric seat
SIX table | Umbra Grey frame and Invisible White porcelain stoneware top
AFRA pendant lamp | Matt White acid-etched glass shade
BLOOM credenza | American Walnut doors and sides, Invisible White porcelain stoneware top and Umbra Grey legs





**The stool version, with
lacquered beech plywood or
natural painted veneered ash or
walnut, is slender, practical and
functional, perfect for shared
and reception interiors.**

La versione sgabello, con scocca laccata in multistrato di faggio o impiallacciata frassino verniciato naturale o noce, è slanciata, pratica e funzionale, perfetta per gli spazi della collettività e dell'ospitalità.





The alluring lines of Code unveil a classic and timeless side, reinterpreted with back and seat cuts and folds inspired by the shapes of the female body.

Le ammalianti linee di Code celano un lato classico senza tempo, rivisitato con tagli e piegature dello schienale e della seduta che si ispirano alle forme del corpo femminile.



Thanks to numerous available finishings, Code is the ideal seat for furnishing multifunctional interiors, with a sinuous style and eccentric touch. Comfort is guaranteed, to be appreciated day after day.

Grazie alle numerose finiture a disposizione, Code è la sedia ideale per arredare ambienti polifunzionali con uno stile sinuoso e un tocco eccentrico. Una garanzia di comodità da apprezzare giorno dopo giorno.



CODE design chair | Umbra Grey lacquered and Oak varnished solid ash wood shell, Chrome legs
T02 coffee table | Oak top and Umbra Grey frame

DESIGN LIVING









designed by Dorigo Design

**Transversal identity.
The heart and soul of the
collection, Cove is sinuous
and enveloping, but also
pure and linear at the same
time: a single concept, in
manifold expressions.**

**Identità trasversale.
L'anima della collezione Cove è sinuosa e
avvolgente, ma allo stesso tempo pura e lineare:
un unico concetto, tante declinazioni.**









COVE outdoor chair | White frame and D06/507 simil leather upholstered seat
COZY coffee table | White frame and top
ACCORD sofa | E03/467 fabric and D06/507 simil leather, Umbra Grey frame



The stool version of Cove is specially designed for hospitality and conviviality. The seat features an upholstered or polypropylene shell; it is comfortable, sturdy and functional, also thanks to the swivel base that is adjustable in height.

La versione sgabello di Cove è dedicata all'ospitalità e alla convivialità. La seduta, con scocca imbottita o in polipropilene, è confortevole, solida e funzionale, grazie anche al basamento girevole regolabile in altezza.



COVE high stool | P01/172 leather and Chrome frame
BOISERIE | White back, Matt White glass shelves and Umbra Grey uprights
TUBE pendant lamp | Black

DESIGN-EWING



COVE design chair | D02/268 and D02/277 fabric, Umbra Grey varnished solid ash wood legs
COZY coffee table | Beige lacquered top and Umbra Grey varnished solid ash wood legs
PETAL acoustic panels | B01/009 fabric
CD LED pendant and table lamp | Black

Residential & Hospitality Collection





COVE design chair | D02/278 fabric and Umbra Grey frame
P1 wall cladding | Oak panels and Umbra Grey tracks

Residential & Hospitality Collection



The essential design of the sled model bestows a sober and elegant character upon this Cove seat. Ideal for refined and formal settings, it provides comfort for all users.

Il design essenziale del modello slitta conferisce a questa seduta Cove un carattere sobrio ed elegante. Ideale per contesti dall'aria raffinata e formale, è pensata per accogliere al meglio ogni persona.





designed by Dorigo Design

**Precious simplicity.
Clue is defined by clear-cut
and graceful lines, which
take centre stage in all
kinds of interiors, in virtue
of their silent beauty.**

**Preziosa semplicità.
Clue è definita da linee nette e cortesi, che
diventano protagoniste in ogni tipologia di
ambiente per la loro silente bellezza.**



CLUE design chair | White polypropylene shell and D02/270 fabric upholstered seat, Walnut varnished solid ash wood legs
TWO table | Canaletto Walnut top and White frame
SUN pendant lamp | White fabric shade





Space becomes a stage just waiting to be filled with colourful fabrics and slender legs: the seat is available with ergonomic upholstery or in polypropylene. Manual flair, clear-cut lines and superlative comfort: this is Clue.

Lo spazio diventa un palcoscenico da riempire con tessuti colorati e gambe slanciate: la seduta è disponibile con imbottitura ergonomica o in polipropilene. Estro manuale, linee nette e comfort totale: questa è Clue.

CLUE design chair | D04/398 fabric and Bronze frame
EIGHT table | Eucalyptus top and Bronze frame
BABEL pendant lamp | Black shade

Residential & Hospitality Collection







CLUE design chair | P01/095 leather and Oak varnished solid ash wood legs
NINE table | American Walnut top and Umbra Grey frame
OLA pendant lamp | White fibreglass shade
MIAMI metal pot | Bronze



SYNTHESIS







designed by Quadrifoglio Group

**Levels of interpretation.
Celsius has an eternal
soul with a spontaneous
shape, expressed in a
multitude of versions,
colours and finishings.**

**Gradi di interpretazione.
Celsius ha un animo eterno dalla forma
spontanea, che si esprime in una pluralità di
versioni, colori e finiture.**





CELSIUS chair | E02/445 fabric and Chrome legs
FIVE table | White top and frame
PLANET pendant lamp | Gold





Celsius is available in the chair and high stool version, ideal for a kitchen, canteen or catering area. The beech plywood shell is solid and rigorous.

Celsius è disponibile in versione sedia e sgabello alto, ideale per una cucina, per una mensa o per uno spazio di ristorazione. La scocca è in legno di faggio multistrato, solida e rigorosa.





Celsius is available in different versions to meet a variety of needs: upholstered and covered, or with the shell in full view and the back embellished by a geometric cut.

È possibile scegliere tra differenti declinazioni di Celsius, a seconda delle proprie esigenze: con imbottitura e rivestimento, oppure con la scocca a vista e lo schienale impreziosito con un taglio geometrico.



CELSIUS chair | Umbra Grey lacquered shell and Chrome legs
X8 meeting table | Canaletto Walnut top and Umbra Grey frame
BLONDE pendant lamp | Black



designed by Edi & Paolo Ciani

**Contemporary conviviality.
Clark is the ideal stool for
residential, hospitality and
catering interiors: modern,
playful and eclectic.**

**Convivialità contemporanea.
Clark è lo sgabello ideale sia per ambienti
residenziali che per spazi di ospitalità e
ristorazione: moderno, giocoso ed eclettico.**







DESIGN LIVING

CLARK high stool | Umbra Grey varnished solid ash wood seat and Umbra Grey frame
T02 high table | Eucalyptus top and Umbra Grey frame



The seat is made up of numerous wooden slats, placed side by side and interspersed with thin slits: a solution that gives stability to the stool and makes the aesthetics dynamic.

Il sedile è composto da numerose doghe in legno, poste una accanto all'altra e intervallate da sottili fessure: una soluzione che dona stabilità allo sgabello e rende dinamica l'estetica.



CLARK high stool | Umbra Grey varnished solid ash wood seat and Umbra Grey frame



CLARK high stool | Oak varnished solid ash wood seat and Matt White frame
ADD pendant lamp | Bronze and White shade



The steel rebar structure and wooden seat create a contrast suitable for rustic, industrial and modern interiors with an understated style: a versatile furnishing piece for residential and contract projects.

La struttura in tondino di acciaio e la seduta in legno creano un contrasto adatto ad ambienti rustici, industriali e moderni dallo stile sobrio: un oggetto d'arredo versatile per la casa e per progetti contract.



C-STOOL

designed by Atelier Studio Borella

**Personal inclination.
C-Stool is the perfect
seat for home and
professional settings:
thanks to its light
inclination, it provides
dynamic comfort and an
active posture.**

**Inclinazione personale.
C-Stool è la seduta perfetta per la casa e per ambienti
professionali: grazie alla sua leggera pendenza, regala un
comfort dinamico e una postura attiva.**









102

C-STOOL high stool | M02/580 fabric and Matt White frame
CREO high table | Oak top and White frame
TV BOX media stand | White
LIBRERIA bookshelves | Olive Green lacquer

**Geometric yet soft, C-Stool
is available in customisable
colours and finishings, to
match the style of interiors and
engage in dialogue with other
furnishing accessories.**

Geometrico e morbido allo stesso tempo, C-Stool
è personalizzabile nei colori e nelle finiture, per
assecondare lo stile dello spazio e dialogare con
gli altri complementi d'arredo.



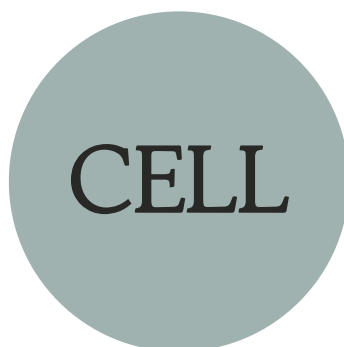

designed by Martin Ballendat

**Practicality in 3D.
Cell combines tradition
and technology: a
metal structure with a
comfortable back and
seat, elaborated thanks
to the 3D technique.**

**Praticità in 3D.
Cell coniuga tradizione e tecnologia:
una struttura in metallo con schienale
e seduta confortevoli, elaborati grazie
alla tecnica 3D.**





CELL chair | Black polypropylene seat and back, Chrome frame
FIVE table | Eucalyptus top and Umбра Grey frame
BLONDE pendant lamp | Black



Cell is ecosustainable as it is made of recycled materials, from the metal structure to the back and seat, all modelled by 3D design. It is customisable in different colours to enhance interior design projects.

Cell è ecosostenibile: i materiali di cui è composta sono riciclati, dalla struttura in metallo, fino allo schienale e al sedile, modellati dal design 3D. È personalizzabile in diversi colori, per valorizzare progetti di interior design.









CELL chair | Blue, Ocher and White
THREE table | Oak top and White frame
CLOAK acoustic panels | B01/012, B01/014 and B01/026 fabric



CELL chair | Blue, Ocher and White
THREE table | Oak top and White frame



Cell is a stackable seat, with armrests designed to also lean against the table top. It is ideal for restaurants, canteens, lounge and relaxation areas: distinctive personality and superlative originality.

Cell è una seduta impilabile, con braccioli studiati per essere appoggiati anche al piano di un tavolo. È ideale per ristoranti, mense, aree lounge e zone relax: forte personalità, grande originalità.



designed by Scagnellato & Ferrarese

**Sitting, together.
Close is a seat featuring
simple lines, available in
numerous finishings and
ideal for conference halls,
classrooms, waiting areas
and cafeterias.**

Sedersi, insieme.

**Close è una seduta dalle linee semplici,
disponibile in numerose finiture e ideale per sale
conferenze, aule, aree d'attesa e caffetterie.**



CLOSE chair | Grey polypropylene shell with B01/014 fabric seat, Chrome frame
COVE design chair | D02/278 fabric and Umbra Grey frame
P1 wall cladding | Oak panels and Umbra Grey tracks



CLOSE chair | Grey polypropylene shell with B01/014 fabric seat, Chrome frame
PETAL acoustic panels | B01/011, B01/014 and B01/020 fabrics

Close is stackable, easy to handle thanks to its lightweight yet robust structure, and available in customisable compositions: stool, bench or single seat with or without a removable writing tablet. Perfect for creating convivial settings of different sizes.

Close è impilabile, facilmente maneggiabile grazie alla sua struttura leggera ma solida, e personalizzabile nella composizione: sgabello, panca, o seduta singola con o senza scrittoio d'appoggio removibile. Perfetta per creare ambienti conviviali di diversa metratura.

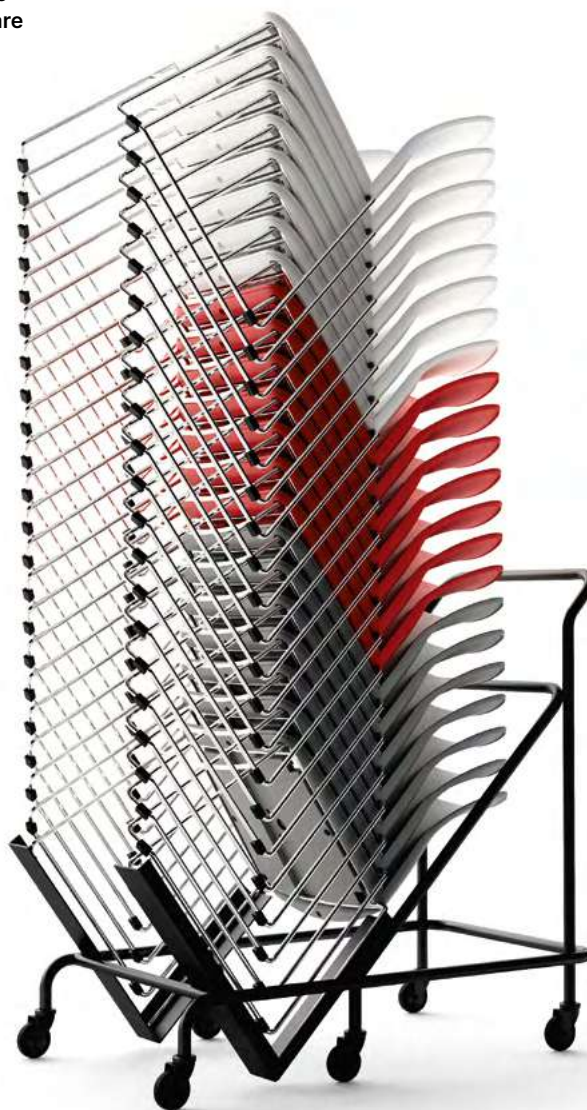



CLOSE chair | White polypropylene shell with M02/584 and M02/569 fabric seat, White frame
X3 bench desk | Oak top, White and Oak legs
LIBRERIA bookshelves | Olive Green lacquer





The inner surface of the backrest features a striped pattern, adding a dynamic effect to the seat. This original detail makes Close suitable for different interior design styles.

La superficie interna dello schienale è lavorata con un motivo rigato per donare dinamismo alla seduta. Questa sua particolarità inedita rende Close adatta a diversi stili di interior design.

CLOSE high stool | White polypropylene shell with M02/584 and M02/569 fabric seat, Chrome frame
CREO high table | Oak top and White legs
LIBRERIA bookshelves | Olive Green lacquer





CLEOPAS

designed by Trevor Hollard & Brado

**Regal comfort.
A majestic and
ergonomic seat, with an
enveloping backrest and
soft upholstery: Cleopas
is the queen of comfort.**

**Comodità regale.
Una struttura maestosa ed ergonomica,
uno schienale avvolgente e un'imbottitura
soffice: Cleopas è la regina del comfort.**











LONDON

PARIS

DUBAI

ROMA

MONTREAL

CLEOPAS armchair | Umbra Grey shell and M01/567 fabric, Umbra Grey base
MONTREAL side table | Noir Desir porcelain stoneware top and Bronze frame

CLEOPAS armchair | Umbra Grey shell and M03/600 fabric, Umbra Grey base
CARTESIO ceiling track with Queen lights | Black
ABBEY pouf | M03/600 fabric





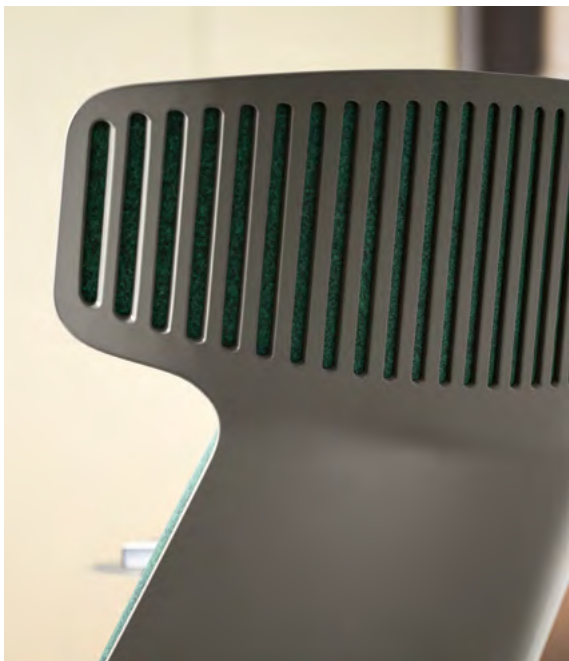

The shell can be customised to create contrasts between vibrant tones or single-colour compositions. Cleopas is also available with a painted backrest featuring a decorative grill pattern. The seat can be completed with a side table.

La scocca è personalizzabile per creare contrasti tra colori vivaci o composizioni monocrome. Cleopas è disponibile anche con lo schienale verniciato e lavorato con motivo decorativo a griglia. La seduta si può completare con tavolino d'appoggio.



CLEOPAS armchair | Umbra Grey shell and M03/600 fabric, Umbra Grey base
ABBEY pouf | M03/600 fabric
CD LED floor lamp | Black

DESIGN LIVING



CLEOPAS armchair and ottoman | E03/463 fabric and Umbra Grey base
MIAMI side table | Fokos Terra porcelain stoneware top and Umbra Grey base
OLA floor lamp | White fibreglass shade and Black base



Residential & Hospitality Collection





The upholstery is designed to be elastic and non-deformable: Cleopas provides superlative comfort in the home, hotel, or other relaxing interiors. It can be matched with an ottoman, for an elegant and comfortable pairing.

L'imbottitura è studiata per essere elastica e indeformabile: Cleopas regala così un comfort superiore in casa, in hotel e in altri ambienti di relax. Si può accompagnare a un poggiatesta in una combinazione elegante e confortevole.



CLEOPAS armchair | White shell, D03/367 and D03/368 fabric, White base
MONTREAL side table | Olive Green lacquered top and Umbra Grey frame

DESIGN LIVING





designed by Edi & Paolo Ciani

**Urban charm.
City Lounge is a range of
soft seats that naturally
take centre stage in any
relaxing interior and
waiting room.**

**Charme urbano.
City Lounge è una famiglia di sedute soft,
protagoniste naturali di ogni ambiente di relax
e delle sale d'attesa.**



CITY LOUNGE armchair | P01/095 leather and Black frame
MIAMI side tables | Noir Desir porcelain stoneware top and Umbra Grey frame
GRACE floor lamp | Natural linen shade and Black base
CITY DÉCO LOUNGE armchair | E04/490 fabric and Bronze frame





CITY LOUNGE armchair | D05/413 fabric and Oak varnished solid ash wood legs
MELBOURNE side table | Fokos Terra porcelain stoneware top and Oak varnished solid ash wood legs



CITY LOUNGE armchair | P01/096 leather and C05/280 fabric, Black base
MONTREAL side tables | Fokos Terra and Fokos Piombo porcelain stoneware top, Umbra Grey base
HALF MOON floor lamp | Black fabric shade and Black base

Residential & Hospitality Collection



The design of City Lounge is curated down to the finest of details, from precious finishings to upholstery, for overall harmony. Elegant and sinuous, the seat is suitable both for contract and living interiors.

Il design di City Lounge è curato nel dettaglio, dalle finiture preziose, all'imbottitura, fino all'armonia d'insieme. Elegante e sinuosa, la seduta è adatta sia per spazi contract che per ambienti living.



CITY LOUNGE armchair | P01/096 leather and C05/280 fabric, Black base
MONTREAL side table | Fokos Terra and Fokos Piombo porcelain stoneware top, Umbra Grey base
HALF MOON floor lamp | Black fabric shade and Black base





The City Lounge line is available in a tall version, with or without a headrest, and a low version, with swivel base, four regular or tubular legs, in wood or metal. The seat can also be fitted with a matching ottoman.

La linea City Lounge è disponibile in versione alta, con o senza poggiatesta, e bassa, con basamento girevole, con le quattro gambe o con quelle tubolari, in legno o metallo. La seduta può essere anche dotata di poggiatesta coordinato.







150

CITY LOUNGE armchair | B03/185 simil leather and Black base
MELBOURNE side table | Umbra Grey lacquered top and Oak varnished solid ash wood legs





CITY DÉCO
LOUNGE

designed by Edi & Paolo Ciani

**Decorative refinement.
City Lounge Déco is
a version of the City
Lounge collection with a
bohémien style, ideal for
vintage style residential
and contract interiors.**

Raffinatezza decorativa.

**City Lounge Déco è una variante della collezione City
Lounge dallo stile bohémien, ideale per ambienti dallo
stile retrò, sia residenziali che contract.**







CITY DÉCO LOUNGE armchair | E04/476 fabric and Bronze frame
MELBOURNE side table | Fokos Terra top and Oak varnished solid ash wood legs
MELBOURNE pouf | E03/464 fabric and Oak varnished solid ash wood legs
GRACE floor lamp | Natural Linen shade and Black base







designed by Dorigo Design

**An archipelago of design.
Ideal for business, home
and hotel interiors, Avana
is a collection of modular
and customisable seats,
for unique furnishing,
every single time.**

**Arcipelago di design.
Ideale per ambienti business, case e hotel,
Avana è una collezione di sedute componibili
e personalizzabili, per progettare ogni volta
un arredo unico.**



AVANA composable sofa | E03/464 fabric, Canaletto Walnut table top and Umbra Grey legs
MIAMI side table | Umbra Grey lacquered top and Umbra Grey frame
MIAMI metal pot | Umbra Grey frame

Residential & Hospitality Collection







AVANA sofa and pouf | E04/490 fabric and Umbra Grey legs
GRACE floor lamp | Natural Linen shade and Black base
MIAMI side table | Emperador Lucido porcelain stoneware top and Umbra Grey frame





AVANA composable sofa | M01/556 fabric, Eucalyptus table top and Umbra Grey legs
MIAMI side table | Fokos Terra porcelain stoneware top and Umbra Grey frame
GRACE floor lamp | Natural Linen shade and Black base
STARLIGHT GIANT wall lamp | Gold



DESIGN LIVING

AVANA composable sofa | D04/387 fabric and Umbra Grey legs
MIAMI side table and pouf | Emperador Lucido porcelain stoneware top, E04/486 fabric and Bronze frame
HALF MOON floor lamp | Black fabric shade and Black base

Residential & Hospitality Collection





Avana is a universe of comfort and practicality: the collection is enriched by accessories including coffee tables, swivel tables and USB sockets. An extensive selection of colours and finishings adds character to any interior.

Avana è un universo di comfort e praticità: la collezione è accessoriata con tavolini rotanti, piani d'appoggio e prese USB. Per conferire carattere a ogni ambiente, è possibile scegliere tra numerosi colori e finiture.

AVANA composable sofa | I02/535 fabric and Umbra Grey legs
MONTREAL side table | Fokos Piombo porcelain stoneware top and Umbra Grey frame
CLARK high stool | Oak varnished solid ash wood seat and Umbra Grey frame
CARTESIO ceiling track with Queen lights | Black





AVANA composable sofa | E02/438 fabric, Oak top and Umbra Grey legs
MELBOURNE side table | Umbra Grey lacquered and Fokos Piombo porcelain stoneware tops, Oak legs
CLEOPAS armchair | E03/463 fabric and Umbra Grey base

Residential & Hospitality Collection







designed by Dorigo Design

**Classic archetype.
The armchair and sofa
from the Arco range
reinterpret the canons of
nordic design and are ideal
for convivial settings.**

**Archetipo classico.
La poltrona e il divano della linea Arco sono
una rivisitazione dei canoni del design
nordico, ideali per luoghi conviviali.**



ARCO sofa and armchair | Walnut varnished solid ash wood frame, M01/554 and M01/556 fabric
T05 coffee table | Umbra Grey lacquer
GRACE floor lamp | Natural Linen shade and Black frame
MIAMI side table | Noir Desir porcelain stoneware top and Umbra Grey frame







The extensive range of materials and finishes enhances the authoritative and rigorous aesthetics of the Arco collection, suitable for contract and home interiors alike, as well as professional firms, waiting areas, lounges and other business settings.

L'ampia gamma di materiali e finiture valorizza l'estetica imponente e rigorosa della collezione Arco, adatta sia per ambienti residenziali che per spazi contract ma anche per studi professionali, aree d'attesa e lounge e altri luoghi aziendali.





ARCO armchair | Walnut varnished solid ash wood frame and I01/519 fabric
MIAMI side table | Invisible White porcelain stoneware top and Umbra Grey frame
GRACE floor lamp | Natural Linen shade and Black frame





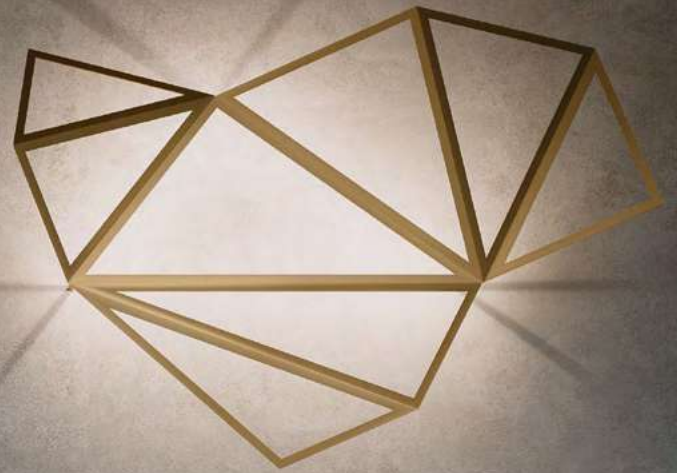

ARCO armchair | Oak varnished solid ash wood frame and E02/446 fabric
MELBOURNE side table | Umbra Grey lacquered top and Oak varnished solid ash wood legs
STARLIGHT GIANT wall lamp | Bronze



The perfect geometry of the square is softened by the delicate upholstery adapted to the continued shape of the legs, which also act as an armrest and confer a square yet inviting volume upon the line.

La geometria perfetta del quadrato viene addolcita dalla morbida imbottitura e addomesticata nella forma continua delle gambe, che fungono anche da bracciolo e conferiscono alla linea un volume squadrato e al contempo accogliente.





designed by Quadrifoglio Group

**Untamed masterpiece.
The art of design is all
about combining beauty
and well-being, which is
masterfully spearheaded
by accessories from the
Arte line.**

**Capolavoro indomito.
L'arte del design è quella di unire bellezza e
benessere: un traguardo raggiunto egregiamente
dai complementi della linea Arte.**



ARTE sofa | I01/519 fabric and Chrome legs
CITY DÉCO LOUNGE armchair | E04/487 fabric and Gold frame
MELBOURNE side table | Invisible White and Nero Greco porcelain stoneware tops, Oak varnished solid ash wood legs
AFRA floor lamp | Matt White acid-etched glass shade



ARTE sofa | E04/480 fabric and Chrome legs
MONTREAL side table | Invisible White and Fokos Piombo porcelain stoneware tops, Umbra Grey frame
Z1 reception desk | Grey White and Beige lacquers
Z1 reception desk | Grey White and Beige lacquers
CARTESIO ceiling track with Bond, Spotlight, Queen and Globe lights | Black

Residential & Hospitality Collection







The enveloping backrest and high armrests encourage the correct and composed posture of guests and clients in waiting rooms, halls, ateliers and other interiors designed to provide a pleasant reception experience.

Lo schienale avvolgente e i braccioli alti favoriscono una postura corretta e composta di ospiti e clienti in sale d'attesa, hall, atelier e altri ambienti dedicati a una garbata accoglienza.



DESIGN LIVING



ARTE sofa | D04/384 fabric and Chrome legs
AGIO armchair | E04/475 fabric and Chrome frame
OLA floor lamp | White fibreglass shade and Black base
MONTREAL side table | Noir-Desir porcelain stoneware and Silk Grey lacquered tops, Bronze frame







ACCORD

designed by Dorigo Design

**Rational design.
Accord is the range of
armchairs and sofas
designed for hospitality
interiors, thanks to its
inviting aesthetic appeal.**

Design relazionale.

**La linea di poltroncine e divanetti Accord trova
la sua naturale collocazione in ambienti dedicati
all'hospitality, grazie alla sua estetica cordiale.**



ACCORD sofa and armchair | E03/467 fabric and D06/507 simil leather, Umbra Grey legs
MIAMI side table | Fokos Piombo porcelain stoneware top and Umbra Grey frame
T05 coffee table | Umbra Grey lacquer







196

ACCORD sofa and armchair | C05/280 fabric and P01/095 leather, Umbra Grey legs
MIAMI side table | Fokos Terra porcelain stoneware top and Umbra Grey frame
T05 coffee table | Eucalyptus
GRACE floor lamp | Natural Linen shade and Black base





The seats are also available in a high backed and sided version, fitted with library tables, USB sockets and magazine rack, for a more pleasant experience while waiting, working or interacting. A perfect ecosystem of privacy and comfort.

Le sedute sono disponibili anche con schienale e fianchi alti, dotate di scrittoi, prese USB e portariviste per rendere più piacevole l'attesa, il lavoro o il dialogo. Un ecosistema perfetto di privacy e comfort.





ACCORD high-back sofa | P01/095 leather and C05/280 fabric, Umbra Grey legs
GRACE floor lamp | Natural Linen shade and Black base
ALALUNGA wall lamp | Bronze
T05 coffee table | Eucalyptus



200







The Accord line is available in numerous tonalities and finishings. Dual-colour solutions are also available, with the customisation of the outer part of the upholstery with fabric or leather, different in colour to the inner one, adding a dynamic and fresh touch.

La linea Accord è disponibile in numerose tonalità e finiture. È possibile scegliere soluzioni bicolor, personalizzando la parte esterna dell'imbottitura con tessuto o pelle di diverso colore rispetto a quella interna per donare dinamismo e freschezza.





designed by Atelier Studio Borella

**Round playfulness.
Abbey, the line of armchairs,
sofas and poufs, is an ode
to softness and harmony,
in a flourish of shapes and
colours.**

**Giocosità rotonda.
La linea di poltrone, divani e pouf Abbey
è un inno alla morbidezza e all'armonia,
tra forme e colori.**









Sinuous and full-bodied shapes inspire playfulness, spontaneous and unconventional use. The seats are available in the armchair and sofa versions, complete with a set of poufs for contract and residential interiors.

Le forme sono sinuose e piene, invitano al gioco e all'utilizzo in modo spontaneo e non convenzionale. Le sedute sono disponibili nella versione poltrona e divanetto, complete di set di pouf per spazi contract e residenziali.









Every single piece of the Abbey line is enriched by artisan stitching, which is deliberately imperfect to highlight the human and warm side of design expressed in this collection.

Ogni pezzo della linea Abbey è arricchito da cuciture a vista artigianali, volutamente imperfette per evidenziare il lato umano e caloroso del design, di cui questa collezione si fa portavoce con la sua esistenza.



ABBEY sofa, armchair and pouf | D03/371, M02/580 and M02/584 fabrics, Umbra Grey varnished beech wood feet
COZY coffee table | Pigeon Blue lacquered top and Matt White frame
BABEL floor lamp | White fabric shade and Matt White base



designed by Dorigo Design

**Original gaze.
Ado is the line that
surprises the gaze with
its square and rigorous
design and sartorial
finishes that embellish
living and contract
interiors.**

**Sguardo inedito.
La linea Ado sorprende l'occhio con il
suo design squadrato e rigoroso e le sue
lavorazioni sartoriali che impreziosiscono
spazi living e contract.**







DESIGN

217

ADO sofa and armchair | B03/181 and B03/185 simil leather, Umbra Grey frame and Walnut varnished solid ash wood arms
WARM floor lamp | White polyethylene shade and Black frame
T05 coffee table | Umbra Grey lacquer

ADO sofa and armchair | B03/181 and B03/185 simil leather, Umbra Grey frame and Walnut varnished solid ash wood arms
WARM floor lamp | White polyethylene shade and Black frame
MIAMI side table | Fokos Piombo porcelain stoneware top and Umbra Grey frame
T05 coffee table | Umbra Grey lacquer

Residential & Hospitality Collection





Ado armchairs and sofas thrive on contrasts: the softness of upholstery and rigour of the structure, wooden armrests and metal legs. Design shows itself in the details.

Le poltrone e i divani Ado vivono di contrasti: la morbidezza dell'imbottitura e il rigore della struttura, il legno dei braccioli e il metallo delle gambe. Il design si rivela nei dettagli.

The shapes of Ado evoke certain stylistic features of Scandinavian: design, essentiality and peacefulness. The seat renews this aesthetic tradition with the Italian style of materials and finishings.

Le forme di Ado richiamano alcuni stili del design scandinavo: geometria, essenzialità, pacatezza. La seduta rinnova questa tradizione estetica con lo stile italiano dei materiali e delle finiture.





ADO armchair | B03/177 simil leather, Umбра Grey frame and Walnut varnished solid ash wood arms
WARM floor lamp | White polyethylene shade and Black frame
COZY coffee table | Umбра Grey lacquered top and Umбра Grey frame

Residential & Hospitality Collection



The wooden arms of the Ado line feature a special finish: an outward-tapered winged volume creates a dynamic effect and provides comfortable support.

I braccioli in legno della linea Ado presentano una lavorazione particolare: un volume ad ala che si assottiglia verso l'esterno, creando un effetto dinamico e garantendo un appoggio confortevole.





ADO sofa and armchair | M01/590 fabric, Umbra Grey frame and Oak varnished solid ash wood arms
ADO coffee table | White top and Umbra Grey frame
MIAMI metal pot | Umbra Grey





designed by Quadrifoglio Group

**Modular constellation.
The Astro and Astro Twist
lines consist of modular
and customisable
armchairs, for the tailored
furnishing of hospitality
interiors.**

Costellazione modulabile.
Le linee Astro e Astro Twist sono composte da
poltroncine componibili e personalizzabili, per
arredare ad hoc ambienti dedicati all'ospitalità.



ASTRO TWIST composable sofa | M02/575 and M02/582 fabrics, Umbra Grey frame
OLA MOVE floor lamp | White fibreglass shade
GOUT pendant lamp | Glossy White glass shade

residential hospitality collection



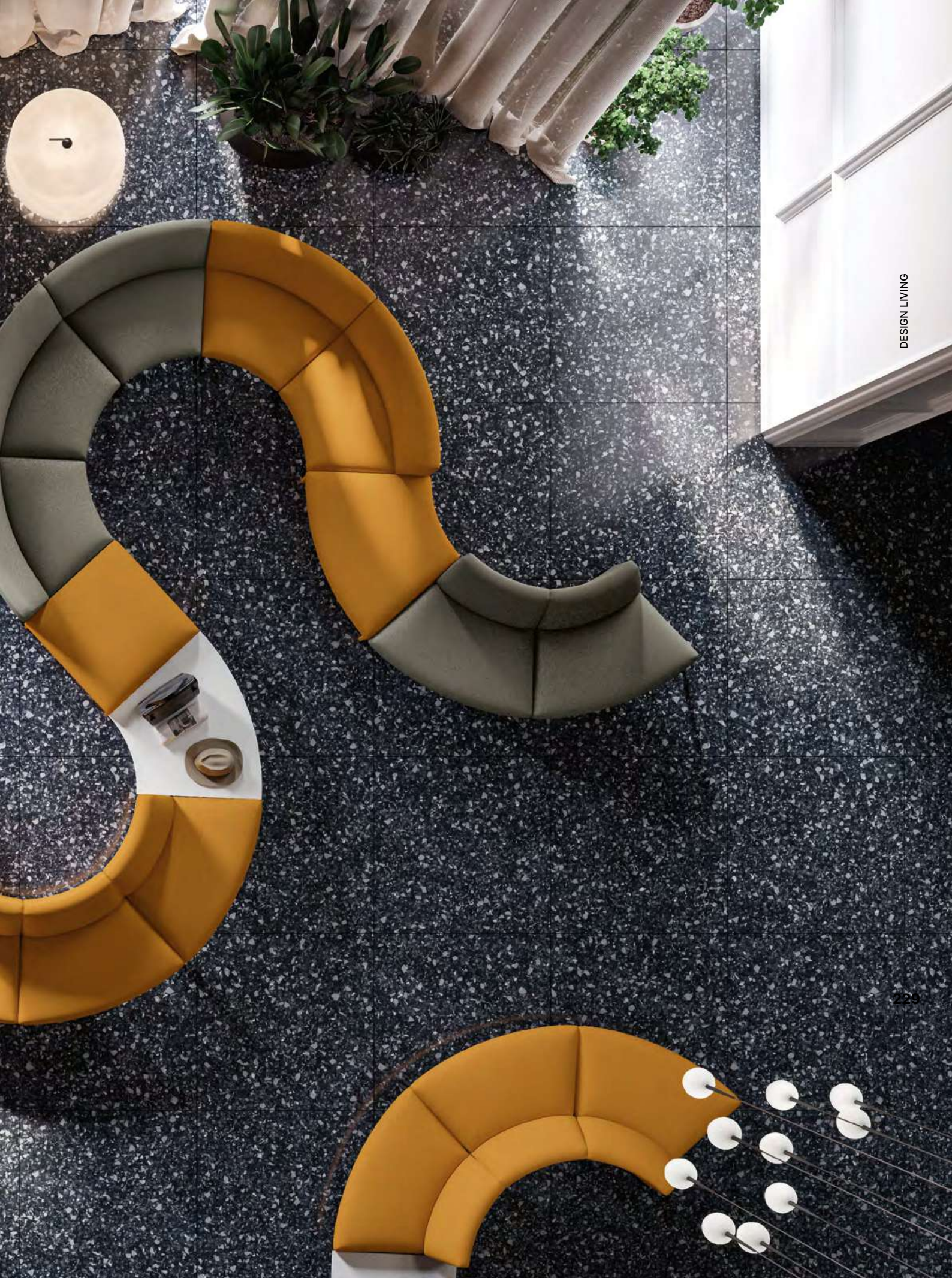

Astro Twist is a version of Astro, featuring rounder lines and ideal for creating curved and soft compositions, with dual-colour matching poufs and coffee tables for personal belongings.

Astro Twist è una variante della versione Astro, dalle linee più tondeggianti: ideale per creare composizioni curve e morbide, con accostamenti bicolor di pouf e tavolini coordinati per appoggiare i propri effetti personali.





ASTRO TWIST composable sofa | E03/460 fabric, Eucalyptus top and Umbra Grey frame
MIAMI side table | Fokos Piombo porcelain stoneware top and Umbra Grey frame
Z2 reception desk | Eucalyptus and Brown leather
MIRAGE pendant lamp | Polished Gold shade





ASTRO TWIST composable sofa | C05/280 and C05/281 fabrics, Umbra Grey frame
MONTREAL side table | Emperador Lucido and Fokos Piombo porcelain stoneware tops, Umbra Grey frame
CITY LOUNGE armchair | P01/096 leather and C05/280 fabric, Black base
HALF MOON floor lamp | Black fabric shade and Black base





ASTRO composable sofa | M03/598 and M03/601 fabrics, Umbra Grey frame
COZY coffee table | White top and frame
CLOAK pendant acoustic panels | B01/026, B01/012 and B01/014 fabrics





ARMONY

designed by Dorigo Design

**Infinite possibilities.
Armony is a modular
system of beam sofas
and side tables, designed
so that the user can
pleasantly occupy time
while waiting in business
and hospitality settings.**

Infinite possibilità.

**Armony è un sistema componibile e
modulare di divanetti a trave e tavolini,
disegnato per ingannare piacevolmente
l'attesa in spazi business e hospitality.**





240

Armony is the result of in-depth research into providing comfort and versatility. The polyurethane upholstery is soft and elastic, while the aluminium legs are solid and essential, seamlessly combining material and intent.

Armony è frutto di una ricerca approfondita, per offrire comodità e versatilità. L'imbottitura in poliuretano è morbida ed elastica, mentre le gambe in alluminio sono solide ed essenziali: un connubio di materia e intento.



ARMONY | E03/467 fabric and Umbra Grey frame
T05 coffee table | Ocean Blue and Sik Grey lacquers
Z1 reception desk | Ocean Blue and Sik Grey lacquers











Armony enhances each project and adapts to shapes and compositions that are always different. Available with different material, finishing and accessory options, sockets can also be added to the structure.

Armony asseconda ogni progetto e si lascia plasmare in forme e composizioni sempre diverse. È possibile scegliere tra materiali, finiture e accessori, integrando nella struttura anche prese elettriche.







designed by Quadrifoglio Group

**A pleasant wait.
Agio is an armchair with
soft and inviting lines,
perfect for waiting rooms,
relaxation areas and
informal meeting spaces.**

Piacevole attesa.

**Agio è una poltroncina dalle linee morbide e
accoglienti, perfetta per sale d'attesa, aree
relax e spazi dedicati a meeting informali.**





250

AGIO armchair | E03/460 fabric and Chrome frame
MONTREAL side table | Nero Greco porcelain stoneware top and Umbra Grey frame
GRACE floor lamp | Natural Linen shade and Black base



Agio can be customised with fabrics and leathers, which exalt its soft profile and precious details, including sartorial stitching and the delicate drapery on the inner back.

Agio si presta a essere personalizzata con tessuti e pelli, che ne esaltino il profilo morbido e mettano in evidenza i dettagli preziosi, quali le cuciture sartoriali e il lieve drappeggio all'interno dello schienale.



AGIO armchair | P01/096 leather and Chrome frame
MONTREAL side table | Invisible White porcelain stoneware top and Umbra Grey frame
TUBE MICRO pendant lamp | Gold



DESIGN LIVING



AGIO armchair | E04/475 fabric and Chrome frame
MONTREAL side table | Noir Desir porcelain stoneware top and Bronze frame
OLA MOVE floor lamp | White fibreglass shade

DESIGN LIVING





designed by Quadrifoglio Group

**Geometric coherence.
Alias is a compact and
rational armchair, suitable
for meeting areas,
waiting rooms, halls and
conference rooms.**

**Coerenza geometrica.
Alias è una poltrona compatta e razionale,
adatta ad arredare spazi per riunioni, sale
d'attesa, hall e aule per conferenze.**









Alias is available in a tub chair version or with a wheel base, to accommodate all needs. Its upholstery guarantees composed and measured comfort, without ever deforming.

A seconda delle esigenze, Alias è disponibile sia nella versione pozzetto, sia in quella con la base dotata di rotelle. L'imbottitura assicura un comfort composto e misurato senza deformarsi.





Accessories & Side Tables Index

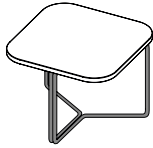

MONTREAL

264 | 271



MIAMI

272 | 281

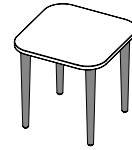

MELBOURNE

282 | 287



COZY

288 | 295

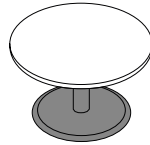

T01

296 | 299

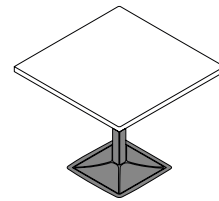

T02

300 | 307

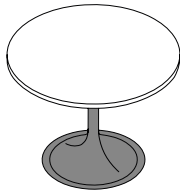

T03

308 | 313

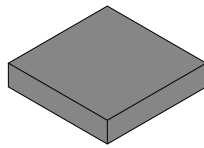

T05

314 | 319

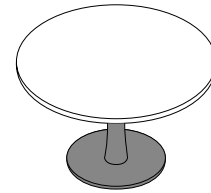

T06

320 | 325



FLIPPER

326 | 331

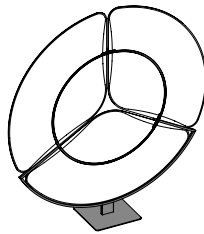

PETAL&CLOAK

332 | 339

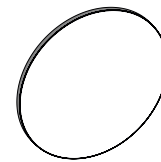

ALTER EGO

340 | 345



MONTREAL

designed by Quadrifoglio Group

**Dynamic lines.
The Montreal collection is
designed for residential
interiors, hotels and
convivial areas, where
the side table becomes a
focal point of areas.**

Linee dinamiche.

La collezione Montreal è disegnata per ambienti
residenziali, hotel e luoghi di convivialità, dove il tavolino
diventa interlocutore privilegiato dello spazio.



MONTREAL side table | Invisible White and Fokos Piombo porcelain stoneware tops, Umbra Grey frame
ARTE sofa | E04/480 fabric and Chrome legs

Residential & Hospitality Collection







The steel rebar base supports the top with grace and lightness, in a harmonious coexistence.

The side tables are available in different heights and finishings, creating unique complicities each time.

La base in tondino di acciaio sorregge il piano con grazia e leggerezza, creando un'armonica convivenza. I tavolini sono disponibili in diverse altezze e finiture, per creare ogni volta complicità uniche.

MONTREAL side table | Invisible White and Nero Greco porcelain stoneware tops, Umbra Grey frame
AGIO armchair | E03/460 fabric and Chrome frame
GRACE floor lamp | Natural Linen shade and Black base

DESIGN LIVING





Montreal table tops are available in different shapes and sizes; they can be customised, with porcelain stoneware, lacquered or melamine options to suit the desired mood.

Il piano dei tavolini Montreal è disponibile in diverse forme e dimensioni e si può personalizzare in gres porcellanato, in laccato o in melaminico, a seconda del mood che si vuole dare all'ambiente.





MONTREAL side table | White lacquered and Noir Desir porcelain stoneware top, Bronze frame
ARTE sofa | D04/384 fabric and Chrome legs
MIAMI metal pot | Umbra Grey



designed by Quadrifoglio Group

**Dual personality.
Understated design and
original finishings coexist in
the Miami collection of side
tables, poufs and containers,
designed for home and
hospitality settings.**

**Personalità duale.
Design minimal e finiture ricercate convivono
nella collezione di tavolini, pouf e contenitori
Miami, pensata per il residenziale e l'hospitality.**



MIAMI side table | Emperador Lucido porcelain stoneware top and Umbra Grey frame
AVANA sofa | E04/490 fabric and Umbra Grey legs

Residential & Hospitality Collection





MIAMI side table | Fokos Piombo porcelain stoneware tops and Umbra Grey frame
ASTRO TWIST composable sofa | E03/460 fabric, Eucalyptus top and Umbra Grey frame
Z2 reception desk | Eucalyptus and Brown leather
MIRAGE pendant lamp | Polished Gold shade





The Miami collection furnishes interiors with grace and coherence and includes containers for belongings fitted with bases of different heights, also designed to act as planters.

Per arredare ogni spazio con garbo e coerenza, nella collezione Miami sono presenti i contenitori per oggetti con basi di diverse altezze, progettati anche per fungere da portavasi per le piante.



Side tables are the leitmotif of this collection: they engage in dialogue with poufs and pots and are available in a multitude of versions, with different heights and top shapes.

I tavolini sono l'elemento di raccordo della collezione: dialogano sia con i pouf che con i contenitori e sono disponibili in molteplici versioni, con altezza e forma del piano differenti.

MIAMI side table | Emperador Lucido porcelain stoneware top and Bronze frame
MIAMI pouf | E04/486 fabric and Bronze frame
AVANA composable sofa | D04/387 fabric and Umbra Grey legs

DESIGN LIVING





The top can be finished with porcelain stoneware, melamine or lacquered options. Its metal edges exalt the style of all settings: from chalets to city apartments, hotels or airports.

Il piano è rifinibile in gres porcellanato, melaminico o laccato. I suoi bordi in metallo esaltano lo stile di ogni contesto: che sia uno chalet, un appartamento di città, un hotel o un aeroporto.







MELBOURNE

designed by Quadrifoglio Group

**Fertile pairings.
Side tables, poufs and
pots from the Melbourne
collection can be
assembled together,
bringing to life to classic
public and private interiors.**

**Fertili combinazioni.
I tavolini, pouf e contenitori della linea Melbourne
sono combinabili tra loro per dare vita a spazi
classici, pubblici e privati.**



MELBOURNE side table | Nero Greco and Invisible White porcelain stoneware top and Oak varnished solid ash wood legs
MELBOURNE pouf | E04/490 fabric and Oak varnished solid ash wood legs
MELBOURNE metal pot | Umbra Grey pot and Oak varnished solid ash wood legs
ARTE sofa | I01/519 fabric and Chrome legs

Residential & Hospitality Collection







The frames of accessories are wooden and feature conical legs, inspired by nordic taste, giving the design a rounder and warmer feel.

Le strutture dei complementi d'arredo sono realizzati in legno e hanno gambe coniche ispirate al gusto nordico, per dare un gusto più rotondo e caloroso al design.





designed by Dorigo Design

**Multiform presence.
Cozy coffee tables are
dynamic, playful and
available in various
shapes and sizes,
ideal for convivial or
private spaces.**

**Multiforme presenza.
I tavolini Cozy sono dinamici e giocosi,
disponibili in varie forme e dimensioni, ideali
per ambienti conviviali o spazi raccolti.**



COZY coffee table | Beige lacquered top and Umbra Grey varnished solid ash wood legs
COVE design chair | D02/268 fabric, Umbra Grey varnished solid ash wood legs
CD LED pendant and table lamp | Black

Residential & Hospitality Collection





Cozy coffee tables with a round or square top are recommended to enhance stylishly even the smallest areas of spaces, and are perfect in home and hospitality settings.

I tavolini Cozy, con piano rotondo o quadrato, sono indicati per valorizzare con stile anche aree dalle metrature ridotte e sono perfetti sia per contesti residenziali che per strutture ricettive.





COZY coffee table | Umbra Grey lacquered top and Umbra Grey varnished solid ash wood legs

COZY coffee table | White and Pigeon Blue lacquered tops, Matt White frame
ABBEY armchair | D03/371, M02/580 and M02/584 fabrics, Umbra Grey varnished beech wood feet
BABEL floor lamp | White fabric shade and Matt White base





Coffee table versions, with a metal structure and tops that are customisable with different tonalities, add colour and personality to shared spaces.

Le versioni dei tavolini con struttura in metallo e piani customizzabili in diverse tonalità donano colore e personalità ai contesti di condivisione.



designed by Quadrifoglio Group

**Regal stability.
The top and base of the T01
coffee tables are round,
appearing reflected in an
impeccable and extensively
customisable symmetry.**

**Imperiosa stabilità.
Il piano e il basamento dei tavolini T01 sono
circolari e sembrano riflettersi in una esemplare
specularità, tutta da personalizzare.**



T01 is available in a tall or low version, with round top. This line is suitable for indoor and covered outdoor settings, for both home and hospitality.

T01 è disponibile in versione alta o bassa, con piano circolare. Questa linea si adatta a contesti indoor e outdoor al coperto in ambienti residenziali o di hospitality.



T01 high tables | Oak top and White frame
COVE high stool | White polypropylene shell and D06/507 simil leather upholstered seat, Chrome frame

DESIGN LIVING





designed by Quadrifoglio Group

**Rational cross-section.
T02 is a series of coffee
tables with a pyramid
base and square top,
designed for essential
interiors with an
understated taste.**

Sezione razionale.

T02 è una serie di tavolini con basamento
piramidale e piano quadrato, pensati per
ambienti essenziali dal gusto minimal.



T02 coffee table | Eucalyptus top and Umbra Grey frame
CITY DÉCO LOUNGE armchair | E04/490 fabric and Bronze frame

Residential & Hospitality Collection





The painted metal base and melamine wood top engage in a matching or contrasting dialogue, creating demure or dynamic pairings, suitable for modern settings.

La base in metallo verniciato e il piano in essenza melaminica dialogano in armonia o per contrasto, creando abbinamenti posati o dinamici, adatti a contesti moderni.



304

T02 coffee table | Oak top and Umbra Grey frame

CODE design chair | Umbra Grey lacquered and Oak varnished solid ash wood shell, Chrome legs



The simplicity of T02 is developed in different shapes and styles: the coffee table is available in three heights, each in turn with different sizes, tops and finishings, furnishing any interior with allure and discretion.

La semplicità di T02 si declina in varie forme e stili:
il tavolino è disponibile in tre altezze, diverse per
dimensione del piano e finiture, per arredare ogni spazio
con decisione e discrezione.



T02 high table | Oak top and Umbra Grey frame
COVE high stool | Oak varnished solid ash wood shell and Chrome legs

DESIGN LIVING





designed by Quadrifoglio Group

**Perpetual essentiality.
T03 is a collection of
coffee tables with a
biconic base and round
top, designed for public
and private settings.**

**Essenzialità perpetua.
T03 è una collezione di tavolini con basamento
biconico e piano circolare, progettati per diversi
contesti, pubblici e privati.**



310

T03 coffee table | Eucalyptus top and Umbra Grey frame
CITY DÉCO LOUNGE armchair | E04/490 fabric and Bronze frame







The melamine top and painted metal base develop in a continuous shape, which is customisable in size, height and finishings, for convivial interiors.

Il piano in melaminico e il basamento in metallo verniciato si articolano in una forma continua, personalizzabile nelle dimensioni, nell'altezza e nelle finiture, per integrarsi in ambienti conviviali.



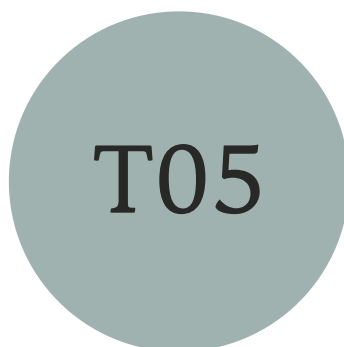

designed by Quadrifoglio Group

**Natural accessory.
T05 is a line of square
or rectangular coffee
tables with powerful and
authoritative volumes, for
the enhanced definition
of spaces.**

**Naturale completamento.
T05 è una linea di tavolini, quadrati o rettangolari,
con volumi possenti e autorevoli, realizzati per
definire al meglio gli spazi.**



T05 coffee table | Eucalyptus
MIAMI side table | Fokos Terra porcelain stoneware top and Umbra Grey frame
ACCORD sofa | C05/280 fabric and P01/095 leather, Umbra Grey legs





**45° angles join lacquered
and melamine tops, adding
character to T05 and enabling
harmonious interaction
with surrounding furnishing
accessories.**

Gli angoli di unione a 45° racchiudono le finiture in laccato e melaminico, donano carattere a T05 e instaurano una relazione armonica con i complementi d'arredo intorno.



318

T05 coffee table | Ocean Blue and Sik Grey lacquers
MIAMI side table | Umbra Grey lacquered top and Umbra Grey frame
ARMONY | E03/467 fabric and Umbra Grey frame



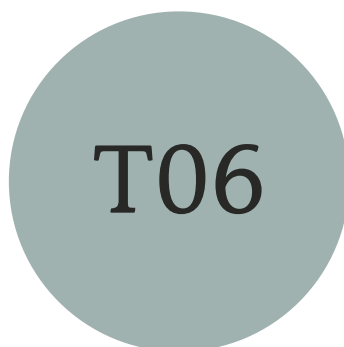

designed by Quadrifoglio Group

**A celebration of
conviviality.
T06 is a table designed
to be at the centre of
convivial moments and is
perfect for restaurants,
cocktail bars and
cafeterias.**

**Celebrazione della convivialità.
T06 è un tavolo nato per essere al centro di
momenti conviviali ed è perfetto per ristoranti,
cocktail bar e caffetterie.**



The classic round table is reinterpreted by the flared leg that joins the painted metal base to the top, customisable in melamine, for enhanced compactness, or glass, for a superlative lightness.

Il classico tavolo tondo è rivisitato dal gambone svasato che unisce il basamento in metallo verniciato e il piano, personalizzabile in melaminico per una maggiore compattezza o in vetro per una totale leggerezza.





323

T06 coffee table | Elm top and Umbra Grey frame
CD LED pendant and table lamp | Black
COVE design chair | D02/268 and D02/277 fabric, Umbra Grey varnished solid ash wood legs







FLIPPER

designed by Edi & Paolo Ciani

**Domestic alliances.
Slender, simple and
functional: Flipper is
a side table that also
acts as a desk for smart
working.**

**Alleanze domestiche.
Snello, semplice e funzionale: Flipper è un tavolino che
funge anche da scrivania per lo smart working.**





FLIPPER home office table | White top and Umbra Grey frame
AVANA composable sofa | E02/438 fabric and Umbra Grey legs
COMPASSO design chair | Walnut varnished solid ash wood frame and D03/363 fabric seat
FIVE table | Canaletto Walnut top and Umbra Grey frame



FLIPPER home office table | White top and Umbra Grey frame
MOON design chair | Umbra Grey polypropylene frame and E01/431 fabric upholstered soft pads
ZEFIRO bookshelves | Umbra Grey lacquer

Residential & Hospitality Collection



Available with a butterfly or four-legged base, featuring a sliding top with a space for sockets and a hide-away book rest. It closes to become a perfect side table for living interiors.

Disponibile con basamento a farfalla o a quattro gambe, ha il piano scorrevole con uno spazio per le prese e un leggio a scomparsa. Una volta chiuso diventa un perfetto tavolino living.





PETAL & CLOAK

designed by Moreno De Giorgio

**Soft silence.
Petal & Cloak is a series
of sound-absorbing
panels designed to
enhance acoustic well-
being in large interiors
and open spaces.**

**Silenzio morbido.
Petal & Cloak è una serie di pannelli
fonoassorbenti pensata per aumentare il
benessere uditivo in spazi ampi e open space.**









336

PETAL floor stand with acoustic panels | B01/020, B01/009 and B01/024 fabrics, Matt White frame
CODE high stool | Oak varnished solid ash wood shell with C05/280 upholstered seat, Chrome frame
ADO sofa and armchair | M01/590 fabric, Umbra Grey frame and Oak varnished solid ash wood arms





338

Petal & Cloak is available in the cascade, ceiling hung or free-standing version with base. The multicoloured panels vibrantly furnish shared interiors and can be customised.

Petal & Cloak è disponibile nella variante a cascata, a sospensione da soffitto o in quella a piantana, con base a terra. I pannelli multicolor arredano con vivacità gli spazi condivisi e possono essere personalizzati.





ALTER EGO

designed by Quadrifoglio Group

**Reflections of identity.
Alter Ego is a collection
of back-lit mirrors that
are perfect for furnishing
lounge areas, restaurants
and bars.**

**Riflessi di identità.
Alter Ego è una collezione di specchi
retroilluminati, perfetti per arredare aree
living, ristoranti e bar.**





Each mirror contains and reflects space, enhancing perception of the interior while spreading a suffused and atmospheric light, ideal for home and hospitality settings.

Ogni specchio contiene e riflette lo spazio, ampliando la percezione dell'ambiente e diffondendo una luce soffusa e atmosferica, ideale sia per ambienti domestici che per locali di hospitality.





344

ALTER EGO mirrors
ADD pendant lamp | Glossy Bronze shade
COVE design chair | E04/475 and E04/476 fabrics and Umbra Grey varnished solid ash wood legs





Living Tables Index

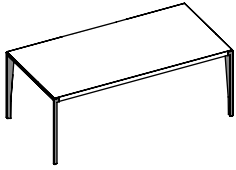

NINE

348 | 353

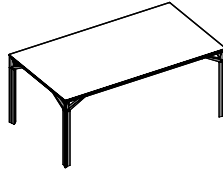

EIGHT

354 | 359

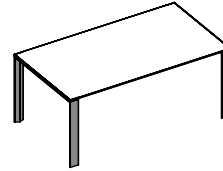

SEVEN

360 | 365

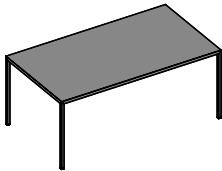

SIX

366 | 373

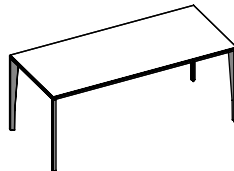

FIVE

374 | 382

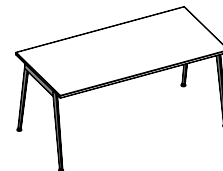

THREE

383 | 388



TWO

389 | 393

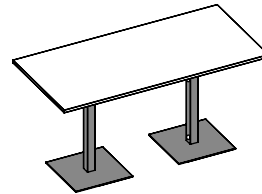

CREO & GREKO

394 | 401



designed by GabrielPolloni Associati

**Aesthetic synthesis.
Nine is the archetype
of the table for sharing,
perfect for dining
rooms, tasting areas or
hospitality interiors.**

Sintesi estetica.

**Nine è l'archetipo del tavolo per la condivisione,
perfetto per una sala da pranzo, un'area degustazione
o un ambiente dedicato all'ospitalità.**



NINE table | Ebony top and Umbra Grey legs
CITY design chair | P01/095 leather and Umbra Grey frame
BLONDE pendant lamp | Gold

Residential & Hospitality Collection





The veneered wood top is built into the metal structure featuring unique carvings. The presence of wood, matched with the matt tonalities of the legs, enhance the refinement of the table, making it an authentic interpretation of interior style.

Il piano in legno impiallacciato è incassato nella struttura in metallo dall'intaglio peculiare. La presenza del legno, accostato alle tonalità opache delle gambe, rende il tavolo pregiato e ne fa un autentico interprete dello stile dell'ambiente.



NINE table | American Walnut top and Umbra Grey frame
CLUE design chair | P01/095 leather and Oak varnished solid ash wood legs
OLA pendant lamp | White fibreglass shade
OLA MOVE floor lamp | White fibreglass shade

DESIGN LIVING





designed by GabrielPolloni Associati

**An orchestra of elements.
A unique table, manifold
ways of experiencing it:
Eight comes with
customisable finishings
so that it matches living
and hospitality interiors.**

Orchestra di elementi.
Un unico tavolo, numerosi modi di viverlo:
Eight è personalizzabile nelle finiture per
intornarlo ad ambienti living o di hospitality.





356

EIGHT table | Umbra Grey lacquered top and Matt White frame
CITY design chair | C05/280 fabric and Walnut varnished solid ash wood
GRACE pendant lamp | Natural Linen shade





358

EIGHT table | Eucalyptus top and Bronze frame
CLUE design chair | D04/398 fabric and Bronze frame
BABEL pendant lamp | Black shade



The shape of the metal legs evokes the profile of a branch, flowing into the clear-cut geometry of the top, customisable with lacquered, glass or melamine in different colour options.

La forma delle gambe in metallo evoca il profilo di un ramo, che confluisce nella geometria netta del piano, customizzabile in laccato, vetro o melaminico di diversi colori.





designed by GabrielPolloni Associati

**Here and now.
Ideal for home or
restaurant kitchens and
dining rooms, Seven
embraces moments of
conviviality.**

Qui e ora.
Ideale per una cucina, per la sala da pranzo di
un'abitazione o di un ristorante, Seven accoglie
intorno a sé i momenti di convivialità.







SEVEN table | Canaletto Walnut top and Chrome frame
DIVA SOFT executive chair | C05/280 fabric
GRACE table lamp | Natural Linen shade and Black base
BOISERIE | Canaletto Walnut back and Umbra Grey lacquered doors



Slender profiles, accompanied by legs, in an open or closed version: Seven can also become a studio desk, based on selected finishings and tonalities, including white, bronze and gold.

Profili sottili, accompagnati da gambe in versione aperta o chiusa: Seven può diventare anche la scrivania di uno studio, a seconda delle finiture e delle tonalità selezionate, tra cui bianco, bronzo e oro.

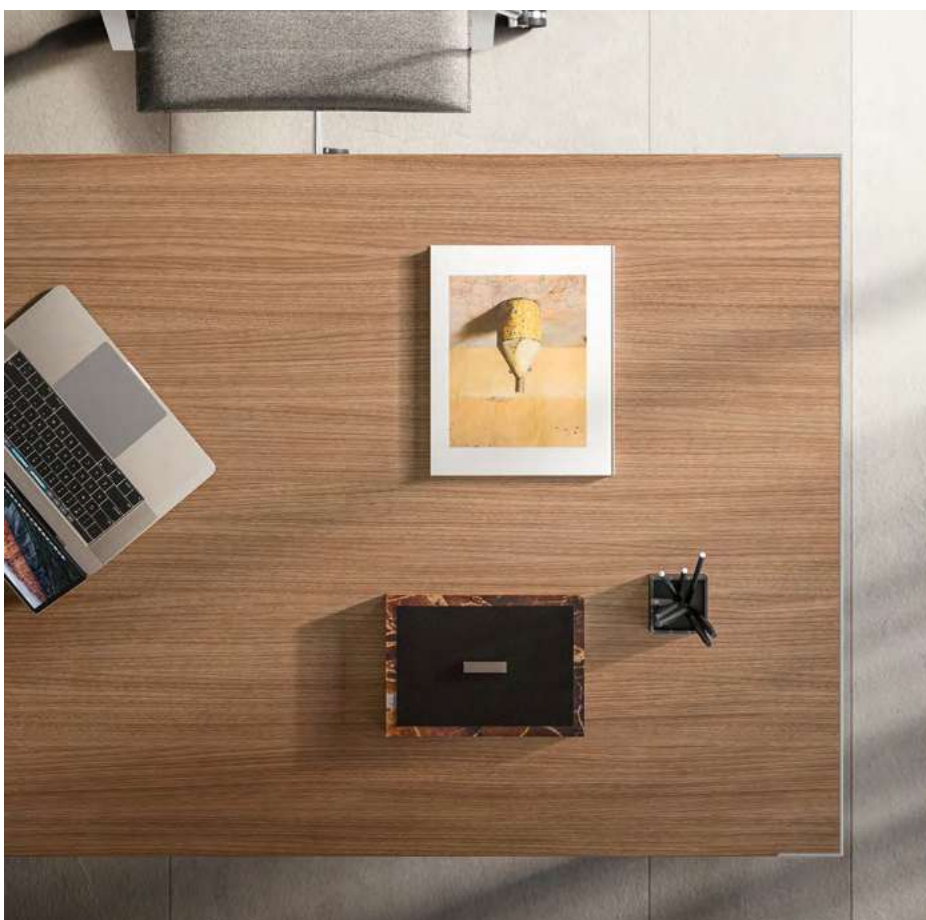



designed by Quadrifoglio Group

**Subtle elegance.
Suitable for residential
and contract interiors,
with its patented design
Six is customisable with
refined finishings that
exalt its slender profiles.**

**Sottile eleganza.
Adatto per ambienti residenziali e contract, Six con
il suo design brevettato, è personalizzabile con
finiture di pregio per esaltarne i profili sottili.**





368





Legs and structure seamlessly blend together in just 30×30 mm, enhancing the table with a slender grace. The product matches different styles, thanks to the extensive selection of available colours and finishings, including porcelain stoneware for the top.

Gambe e struttura si fondono in soli 30×30 mm e conferiscono al tavolo una grazia esile. Il prodotto asseconda stili differenti, grazie all'ampia scelta di colori e finiture a disposizione, tra cui il gres porcellanato per il piano.

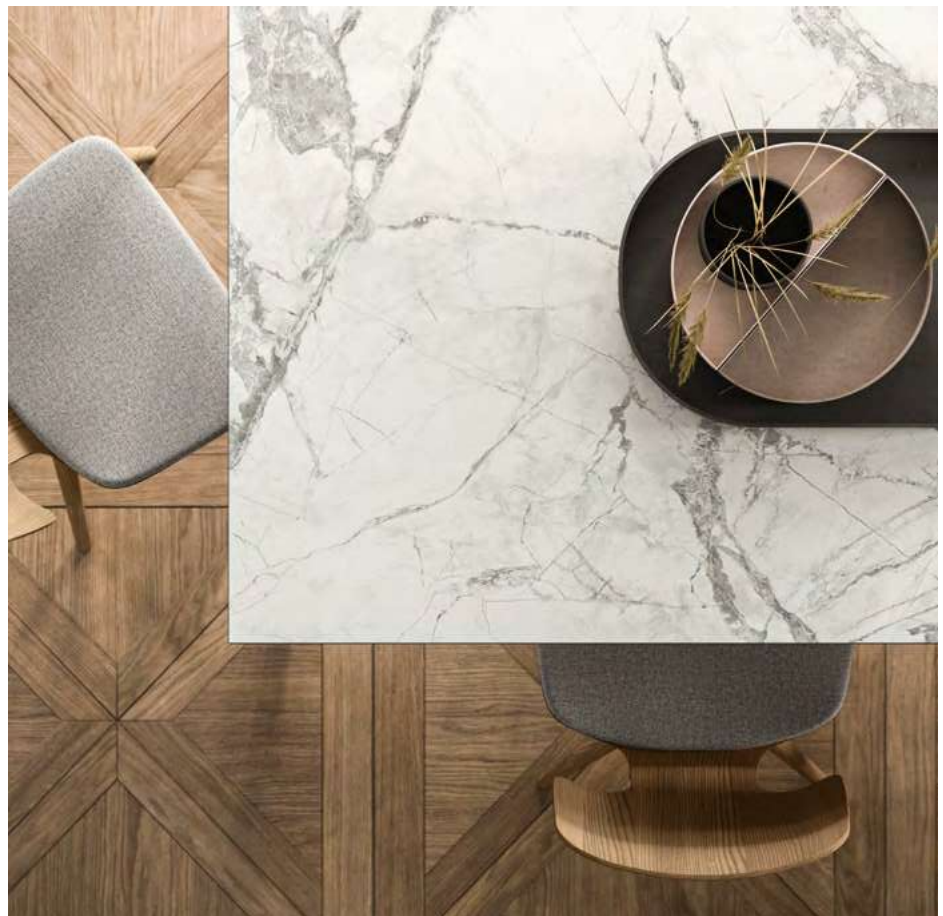

SIX table | Umbra Grey frame and Invisible White porcelain stoneware top
CODE design chair | Walnut varnished solid ash wood legs and shell, C05/280 fabric seat
BLOOM credenza | American Walnut doors and sides, Invisible White porcelain stoneware top
AFRA pendant lamp | Matt White acid-etched glass shade



372

SIX table | Matt white frame and Invisible White porcelain stoneware top
CELL chair | Blue and Ocher
WARM floor lamp | White polyethylene shade and Black frame





designed by GabrielPolloni Associati

**Ubiquitous potential.
Home office, kitchen,
restaurant, cocktail bar:
Five enhances any interior
with its structure featuring
a distinctive folding.**

**Potenziale ubiquo.
Home office, cucina, ristorante, cocktail bar: non c'è
ambiente che Five non sappia valorizzare con la sua
struttura dalla piegatura distintiva.**





376

FIVE table | Eucalyptus top and Umbra Grey frame
COMPASSO design chair | Umbra Grey varnished solid ash wood frame and B03/185 simil leather seat
CARTESIO ceiling track with Globe lights | Black





378

FIVE table | Canaletto Walnut top and Umbra Grey frame
COMPASSO design chair | Walnut varnished solid ash wood frame and E04/475 fabric seat
ADD pendant lamp | Matt clay shade





Five is designed for contract and home use; it is available in different sizes and the top can either be 80mm or 90mm in depth. The surface top is available in eight melamine versions, which can be paired with legs of different colours.

Five è disegnato per destinazioni d'uso contract e private: è disponibile in diverse dimensioni e il piano può avere profondità 80mm o 90mm. La superficie d'appoggio è realizzabile in otto varianti di melaminico, da accostare ai diversi colori delle gambe.



FIVE table | Umbra Grey frame and Whitened Elm top
CODE design chair | Walnut varnished solid ash wood legs and shell, C05/303 fabric seat
P1 BOISERIE | Whitened Elm panels and shelves, Umbra Grey tracks





designed by Quadrifoglio Group

**Multiple identity.
Customisable and versatile:
Three is perfect for canteens,
restaurants or home interiors as
a library table for the bedroom.
Its design is linear yet distinctive,
featuring an understated leg
with a conical section, the
fulcrum of its personality.**

Identità molteplice.

Personalizzabile e versatile: Three è perfetto per mense, ristoranti o contesti residenziali come scrittoio. Il suo design è lineare eppure peculiare con la gamba minimal a sezione conica, il fulcro della sua personalità.



THREE table | Umbra Grey and Oak legs, Umbra Grey lacquered top
CITY design chair | E03/467 fabric and Oak varnished solid ash wood legs
MINISTICK table lamp | Black
ABBEY pouf | E03/467 and E03/465 fabrics







386

THREE table | Oak top and Umbra Grey legs
CODE design chair | Oak varnished solid ash wood shell and legs





designed by Quadrifoglio Group

**Visions of style.
Two is the natural
addition to home interiors
as a living room table,
ideal for lunch, studying
or working.**

**Visioni di stile.
Two trova la sua naturale collocazione in
ambienti residenziali come tavolo da salotto,
ideale per pranzare, studiare o lavorare.**



TWO table | Canaletto Walnut top and White frame
CLUE design chair | White polypropylene shell and D02/270 fabric upholstered seat, Walnut varnished solid ash wood legs
BOISERIE | Canaletto Walnut back and Silk Grey lacquered top
SUN pendant lamp | White fabric shade



Two is available with an oval or square melamine top, in a selection of nine different versions. The tubular legs can be customised in white, grey or aluminium and ramify on the floors, bringing to life a table with an original appearance.

Two è disponibile con piano in melaminico ovale o quadrato, a scelta tra 9 tipi di varianti. Le gambe tubolari, personalizzabili in bianco, grigio o alluminio, si ramificano a terra dando al tavolo un aspetto ricercato.



TWO table | Eucalyptus top and Umbra Grey frame
DOVE design chair | D02/275 fabric and Umbra Grey frame
MIRAGE pendant lamp | Gold

DESIGN LIVING





CREO & GREKO

designed by Quadrifoglio Group

**Close destinies.
Creo and Greko are two
tables featuring a geometric
and rigorous design,
which welcome people
in meticulously designed
convivial interiors.**

Destini fratelli.

**Creo e Greko sono due tavoli dal design
geometrico e rigoroso, capaci di accogliere le
persone in spazi conviviali progettati con cura.**



GREKO high table | Elm top and Umbra Grey frame
COVE high stool | C05/280 fabric and Chrome legs
HALF MOON floor lamp | Black fabric shade and Black frame

Residential & Hospitality Collection





**Creo and Greko provide
infinite customisation
possibilities, thanks
to tops available in
different sizes.**

Creo e Greko offrono infinite possibilità
di personalizzazione, grazie ai piani
realizzabili in diverse dimensioni.



CREO high table | Oak top and White frame
CELSIUS high stool | White and Ocher lacquered shell and Chrome legs
DRINK pendant lamp | White

DESIGN LIVING







CREO high table | Oak top and Umbra Grey frame
CODE high stool | Oak shell and D04/386 fabric seat, Chrome frame
CODE design chair | Umbra Grey lacquered shell and legs, B03/185 simil leather seat
COZY coffee table | Umbra Grey lacquered top and Umbra Grey varnished solid ash wood frame



Storage & Partitioning Index

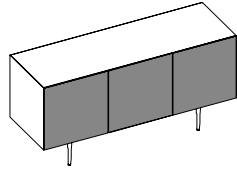

BLOOM

404 | 413

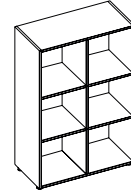

ZEFIRO

414 | 419

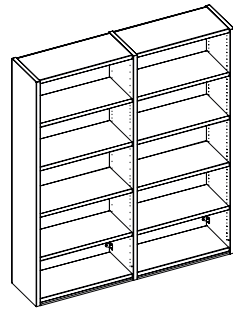

LIBRERIA

420 | 425

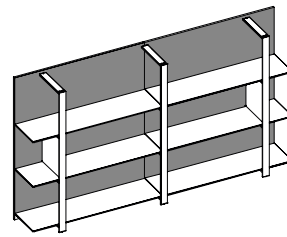

BOISERIE

426 | 431

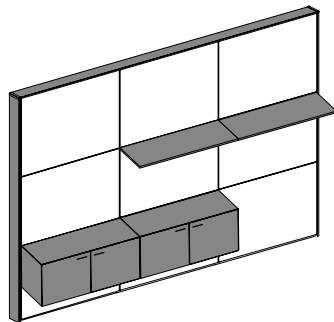

P1
BOISERIE

432 | 437

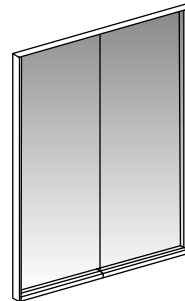

M3

438 | 445



designed by Quadrifoglio Group

**A flourish of design.
Bloom is the credenza
designed by Quadrifoglio
Group to furnish
entrances, lounges and
bedrooms in home and
hospitality settings.**

Design sbocciato.

Bloom è la credenza firmata Quadrifoglio Group,
disegnata per arredare ingressi, soggiorni e camere
da letto in contesti living e hospitality.



BLOOM credenza | invisible White porcelain stoneware top, Umbra Grey lacquered doors and sides, Umbra Grey Flair legs
M3 glazed partition | Umbra Grey tracks
ALTER EGO mirrors





The aesthetic appeal of Bloom is also due to the absence of handles on doors, which are fitted with a push&pull mechanism, and the 45° joints, generating a continuous form for the eye to behold. Bloom is customisable with materials selected to embellish interiors.

L'estetica essenziale di Bloom è merito delle ante senza maniglie, dotate di un meccanismo push&pull e delle giunzioni angolari a 45°, che suggeriscono all'occhio una forma continua. Bloom è personalizzabile con materiali selezionati per impreziosire gli spazi.







410



Bloom responds to different functional requirements: it is fitted with internal glass shelves that can be removed if not used; numerous customisation options are also available, from finishings to feet.

Bloom risponde a esigenze di funzione diverse: è accessoriata con ripiani interni in vetro che si possono rimuovere se non utilizzati e offre varie possibilità di personalizzazione, dalle finiture ai piedini.



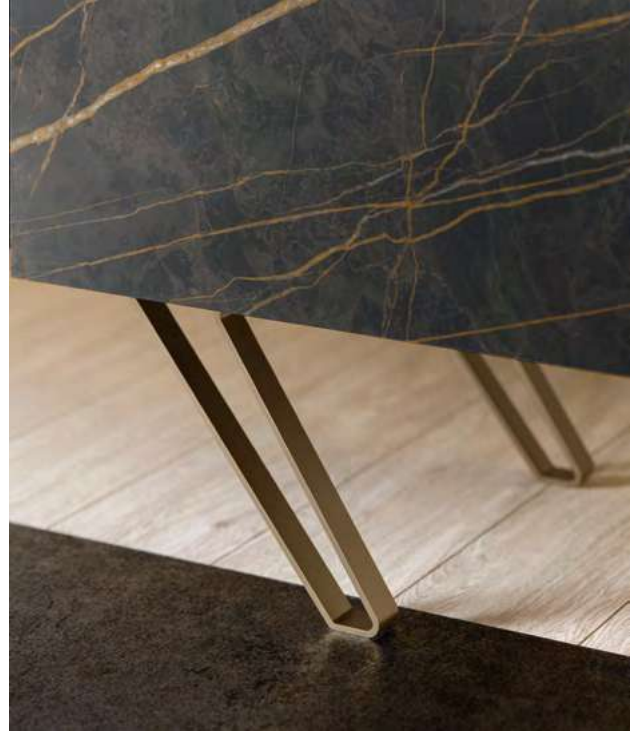

The feet are also customisable with Bloom, available in different shapes, like the more classic wooden Eden or the more outgoing metal Flair, setting the tone for interiors.

Bloom è customizzabile anche nei piedini, disponibili di diverse forme, come il modello più classico Eden in legno o il più estroso Flair in metallo, per dettare il carattere degli ambienti.





designed by Quadrifoglio Group

**A puff of lightness.
An open bookcase
with an understated
design, modular and
customisation for home
and Ho.Re.Ca settings.**

**Soffio di leggerezza.
Una libreria a giorno dal design minimal e leggero,
componibile e personalizzabile per ambienti
residenziali e Ho.Re.Ca.**





Univocal furnishing with manifold styles, generated by the selection of finishings and tonalities. Lacquered or melamine, with abs or metal feet available in different shape. Zefiro fulfils all project requirements.

Un arredo univoco con molteplici stili a seconda delle finiture e delle tonalità che si scelgono. Laccato o melaminico, con piedini in abs o metallo di diverse forme: Zefiro asseconda ogni esigenza di progetto.



ZEFIRO bookshelves | Pigeon Blue lacquer with Classic White legs
TURN ME! wall lamp | Matt White
ABBEY pouf | E04/491 fabric
ALTER EGO mirror

DESIGN LIVING





Zefiro is available in a basic, maxi and super version, adapting to interiors of different sizes, and is customisable with tailored melamine, leather or veneered wood doors, matching with the palette.

Zefiro è modulabile in versione base, maxi e super per adattarsi a contesti di diversa metratura ed è personalizzabile con ante su misura in melaminico, cuoietto o impiallacciato, coordinate alla palette d'insieme.





LIBRERIA

designed by Quadrifoglio Group

**An architecture of
knowledge.
A modular structure,
perfect for studios,
offices, waiting rooms
and lounge areas,
customisable with
numerous finishings.**

**Architettura del sapere.
Una struttura modulare perfetta per studi, uffici,
sale d'attesa e zone lounge, customizzabile in
numerose finiture.**





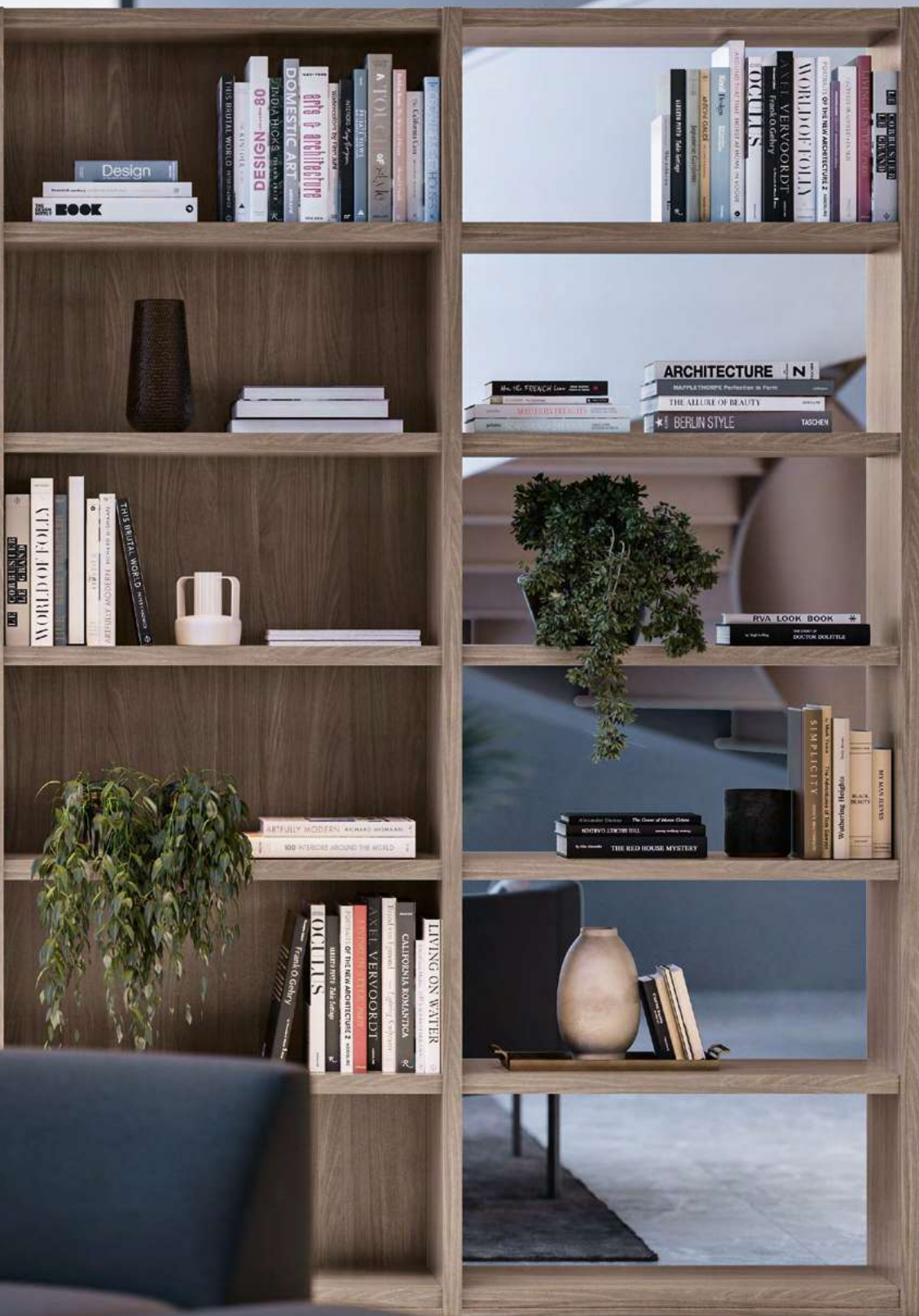





LIBRERIA bookshelves | Umbra Grey lacquer
CLEOPAS armchair and ottoman | E03/463 fabric and Umbra Grey base
MIAMI side table | Fokos Terra porcelain stoneware top and Umbra Grey base



BOISERIE

designed by Quadrifoglio Group

**Tradition, reinvented.
A modular composition
of shelves and units, with
customisable finishings:
ideal for home offices,
shared spaces or hotel
reception areas.**

**Tradizione reinventata.
Una composizione modulabile di ripiani e mobiletti,
personalizzabile nelle finiture: ideale per un home office, uno
spazio condiviso o un'area di accoglienza in hotel.**



BOISERIE | Canaletto Walnut back and Umbra Grey lacquered doors, Chrome uprights
SEVEN table | Canaletto Walnut top and Chrome frame
DIVA SOFT executive chair | C05/280 fabric

Residential & Hospitality Collection







430

BOISERIE | Canaletto Walnut back and Silk Grey lacquered doors, White uprights
MOON design chair | White polypropylene shell and E01/421 fabric upholstered soft pads





designed by Quadrifoglio Group

**Optimised space.
P1 is a boiserie with
built-in shelves and
units, furnishing walls
with personality,
adding elegance and
functionality to home or
professional interiors.**

**Spazio ottimizzato.
P1 è una boiserie con mensole e mobili
integrati nei pannelli, per arredare una parete
con personalità e rendere eleganti e funzionali
contesti residenziali o professionali.**





434

P1 Boiserie | American Walnut panels and shelves
CITY design chair | E04/488 fabric and Gold frame
MELBOURNE metal pot | Umbra Grey pot and Oak varnished solid ash wood legs



P1 Boiserie | Ebony panels and Umbra Grey lacquered floating elements
BABEL floor lamp | Black fabric shade and Matt White base
MONTREAL side table | Fokos Piombo porcelain stoneware top and Umbra Grey frame

Residential & Hospitality Collection







designed by Quadrifoglio Group

**Redrawing the boundaries.
M3 is a system of dividing
and sound-absorbing
glass walls that are
perfect for delicately
configuring living and
hospitality interiors.**

Ridisegnare i confini.

**M3 è un sistema di pareti divisorie e fonoisolanti
in vetro, perfette per configurare spazi living e
hospitality con delicatezza.**



M3 glazed partition | Bronze tracks
ABBEY pouf | E04/492 fabric

Residential & Hospitality Collection

440



M3 consists of single-slab glasses and is characterised by slender and discrete profiles, customisable in wood, bronze, corten, gold and other colours, articulating spaces of walk-in wardrobes, dining rooms or relaxation areas, enveloping people in padded acoustic comfort.

M3 è composto da vetri monolastra ed è caratterizzato da profili snelli e discreti, customizzabili in legno, bronzo, corten, oro e altri colori, per articolare gli spazi di cabine armadio, sale da pranzo o zone relax, avvolgendo le persone in un comfort acustico ovattato.







DESIGN LIVING

KINFOLK
KINFOLK
STONE NUDES
HOMES
Jacques-Henri LARTIGUE
Three Contemporary Interiors

The M3 system provides hinged or sliding door options as well as a choice of handles. Glasses are also available in a matt version to guarantee more privacy.

Il sistema M3 offre la possibilità di scegliere tra porte a battente o scorrevoli e tra diverse tipologie di maniglie. I vetri sono disponibili anche in versione opacizzata per garantire maggior privacy.



M3 glazed partition | Elm covered tracks
OLA pendant lamp | White fibreglass shade
COVE design chair | E04/488 fabric and White frame
SIX table | Invisible White porcelain stoneware top and Matt White frame





1.

2.



6.

7.



3.



4.

5.

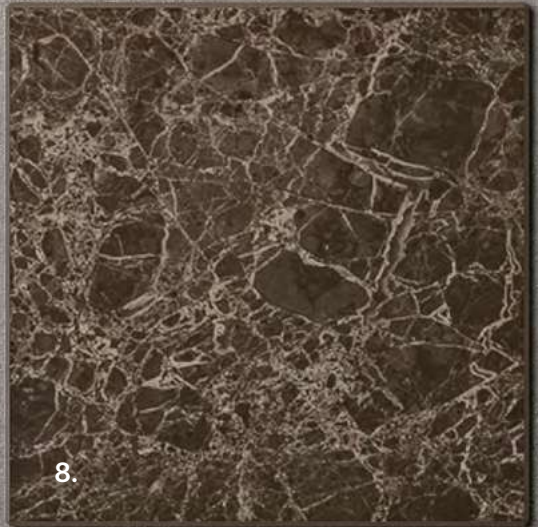

8.

WARM COLOURS MOODBOARD

Walnut, dark brown, beige and grey nuances mingle to generate an earthy and homely ambience, ideal for warm, friendly and prestigious settings.

Nuance di noce, testa di moro, beige e grigio si accostano restituendo un'atmosfera di terra e appartenenza, ideale per ambienti calorosi, affabili e prestigiosi.



residential.it - pin.it/colofon



2.

3.

1.



4.



6.



5.



7.



8.

448

COOL COLOURS MOODBOARD

Smooth porcelain stoneware surfaces and fabric patterns conquer space, expressed by veinings and shininess, between tenuous and abstract tonalities.

Superfici lisce di gres porcellanato e trame di tessuti conquistano lo spazio, articolandosi in venature e lucentezze, tra tonalità polverose e astratte.



450

6.



1.



2.



3.



4.



5.



7.



8.



9.

NATURAL COLOURS MOODBOARD

**Fertile contrasts between
tenuous and vibrant colours,
like burnt orange and corten,
invite the eye to a light dance,
in places that evoke nature,
welcoming and decisive.**

Contrasti fertili tra colori tenui e accesi come
l'arancio bruciato e il corten invitano l'occhio a una
danza leggera e lo fanno accomodare in luoghi che
richiamano la natura, accoglienti e decisi.

1. Fokos Terra porcelain stoneware (LFT) / Gres porcellanato Fokos Terra (LFT) 2. Corten metal (CO) / Metallo Corten (CO)
3. Light Beige lacquer (NK) / Laccato Beige Chiaro (NK) 4. Burnt Orange lacquer (NJ) / Laccato Arancio Bruciato (NJ)
5. Umbra Grey lacquer (LO) / Laccato Grigio Ombra (LO) 6. Whitened Elm (OB) / Olmo Sbiancato (OB)
7. D03/375 fabric / Tessuto D03/375 8. D03 /377 fabric / Tessuto D03 /377 9. D03/363 fabric / Tessuto D03/363

UNION

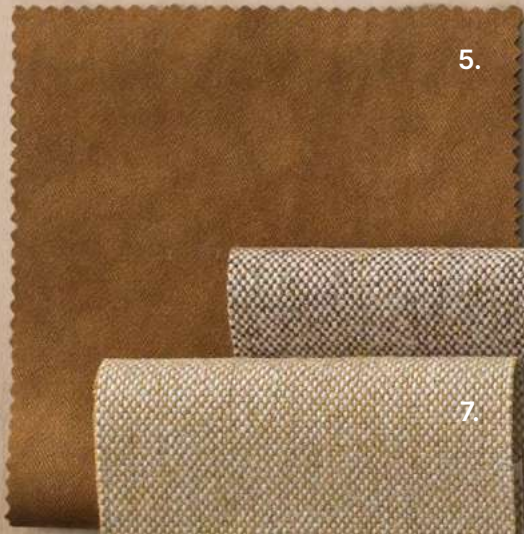

ELEGANCE COLOURS MOODBOARD

Velvet, fabric and porcelain stoneware modulate sober yet precious interiors, defining the personality of sophisticated and exclusive places.

Velluto, tessuto e gres porcellanato modulano contesti sobri ma preziosi e definiscono la personalità di luoghi sofisticati ed esclusivi.

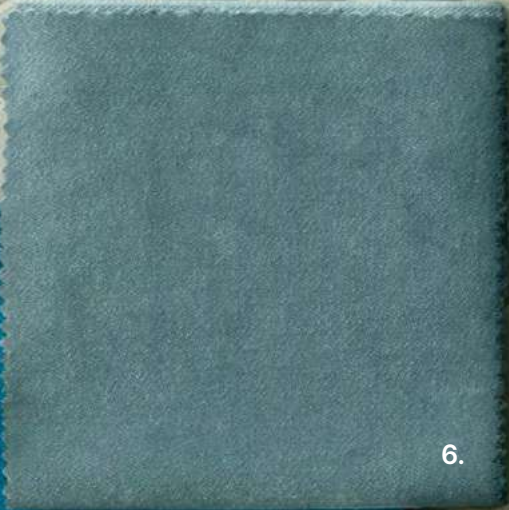

ECLECTIC COLOURS MOODBOARD

Unexpected and surprising pairings between marine, candid and earthy tonalities furnish shared and meeting interiors with original grace.

Accostamenti inaspettati e sorprendenti tra tonalità marine, candide e di terra arredano contesti di condivisione e incontro con inedita grazia.

1. Invisible White porcelain stoneware (LIW) / Gres porcellanato Invisible White (LIW)
2. Ocean Blue lacquer (LD) / Laccato Blu Oceano (LD)
3. Matt White metal (O) / Metallo Bianco Opaco (O)
4. Eucalyptus (EC) / Eucalipto (EC)
5. D04/399 fabric / Tessuto D04/399
6. E04/491 fabric / Tessuto E04/491
7. E04/484 fabric / Tessuto E04/484
8. E04/487 fabric / Tessuto E04/487

Shapes and sizes

Abaco degli elementi

Residential & Hospitality Collection

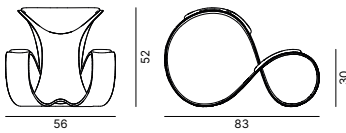

SHELL FINISH OPTIONS
FINITURE DISPONIBILI SCOCCA

POLYMERS
PLASTICA



PAD FINISH OPTIONS
FINITURE DISPONIBILI PAD

FABRICS AND LEATHERS
TESSUTI E PELLI



E01: 417/428/429/431/421/420

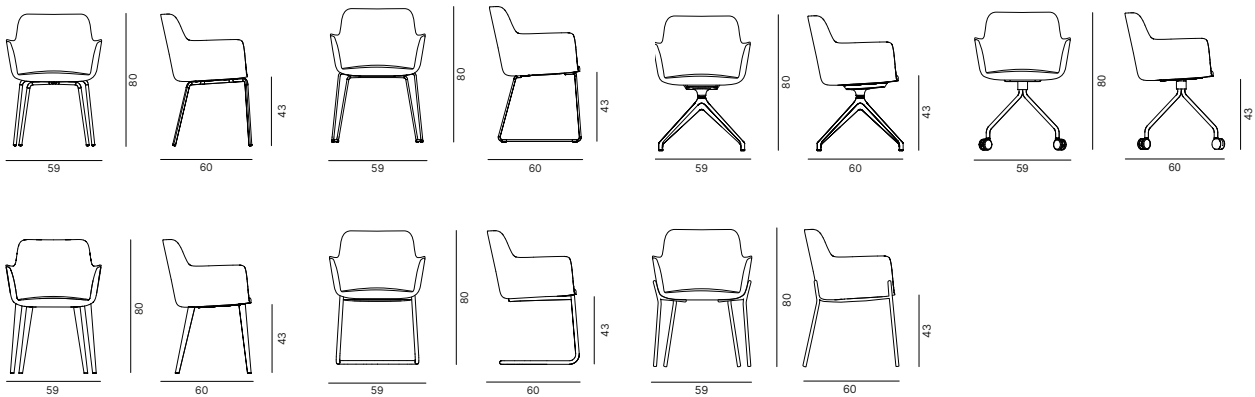

BASE FINISH OPTIONS
FINITURE DISPONIBILI BASE

METAL
METALLO



SOLID ASH WOOD
FRASSINO MASSELLO



UPHOLSTERY
RIVESTIMENTI

FABRICS AND LEATHERS
TESSUTI E PELLI



B01-B03-C01-C05-D02-D03-D04-D05-D06-
P01-E01-E02-E03-E04-I01-I02-M01-M02-M03

Design Chairs & Soft Seating

CITY DÉCO

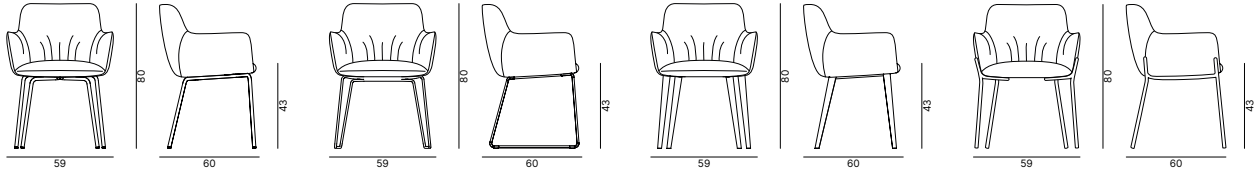

BASE FINISH OPTIONS FINITURE DISPONIBILI BASE

METAL METALLO



SOLID ASH WOOD FRASSINO MASSELLO



UPHOLSTERY RIVESTIMENTI

FABRICS AND LEATHERS TESSUTI E PELLI



D02-D03-D04-D05-E01-
E02-E03-E04-I01

Design Chairs & Soft Seating

COMPASSO

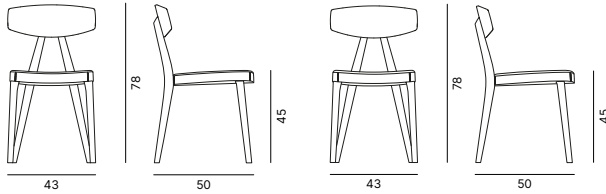

FRAME FINISH OPTIONS FINITURE DISPONIBILI STRUTTURA

SOLID ASH WOOD FRASSINO MASSELLO



BACK & SEAT FINISH OPTIONS FINITURE DISPONIBILI SEDILE E SCHIENALE

SOLID ASH WOOD FRASSINO MASSELLO



SEAT FINISH OPTIONS FINITURE DISPONIBILI SEDILE

FABRICS AND LEATHERS TESSUTI E PELLI



B03-C05-D02-D04-D05-P01-
E01-E02-E03-E04-I01-I02

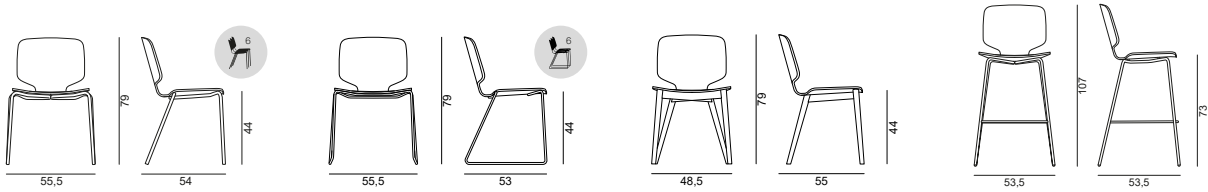

BASE FINISH OPTIONS
FINITURE DISPONIBILI BASE

METAL
METALLO



SOLID ASH WOOD
FRASSINO MASSELLO



LACQUERED
LACCATO



SHELL FINISH OPTIONS
FINITURE DISPONIBILI SCOCCA

SOLID ASH WOOD
FRASSINO MASSELLO



LACQUERED
LACCATO



SEAT FINISH OPTIONS
FINITURE DISPONIBILI SEDILE

FABRICS AND LEATHERS
TESSUTI E PELLI

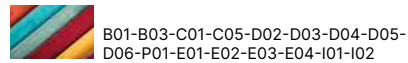



BASE FINISH OPTIONS
FINITURE DISPONIBILI BASE

METAL
METALLO



SOLID ASH WOOD
FRASSINO MASSELLO



SHELL FINISH OPTIONS
FINITURE DISPONIBILI SCOCCA

POLYMERS
PLASTICA

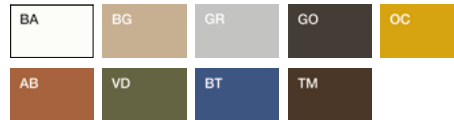

FABRICS AND LEATHERS
TESSUTI E PELLI

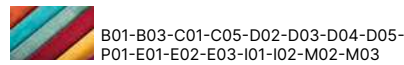

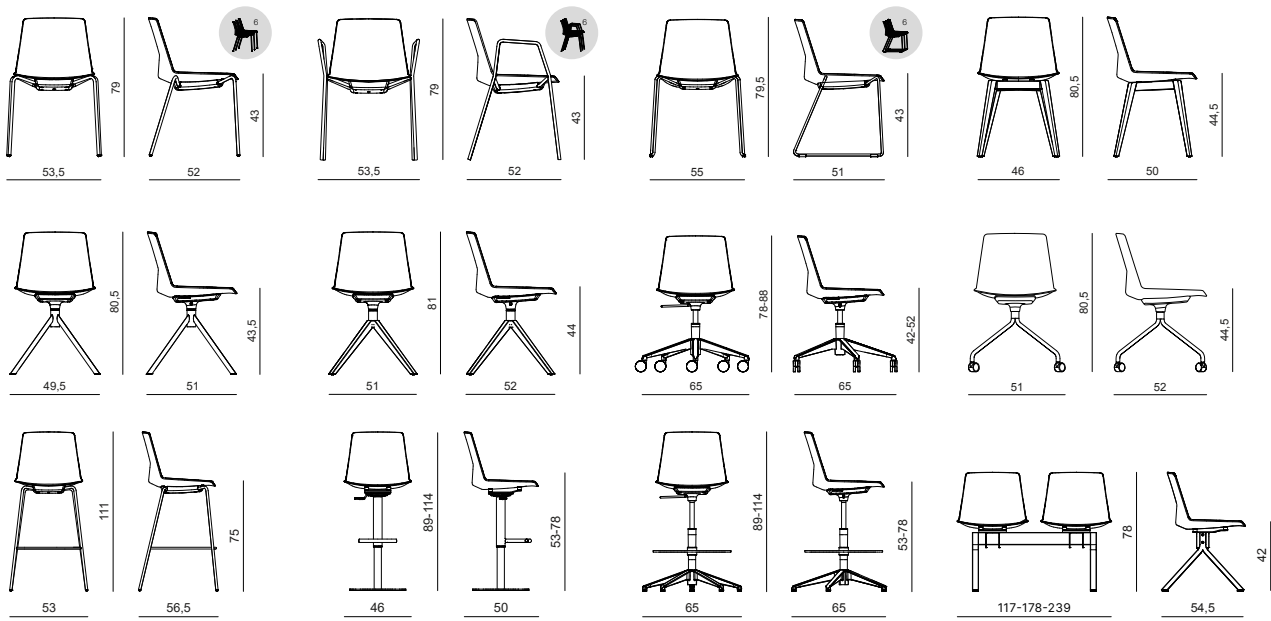

BASE FINISH OPTIONS
FINITURE DISPONIBILI BASE

METAL
METALLO



SOLID ASH WOOD
FRASSINO MASSELLO



SHELL FINISH OPTIONS
FINITURE DISPONIBILI SCOCCA

POLYMERS
PLASTICA



FABRICS AND LEATHERS
TESSUTI E PELLI

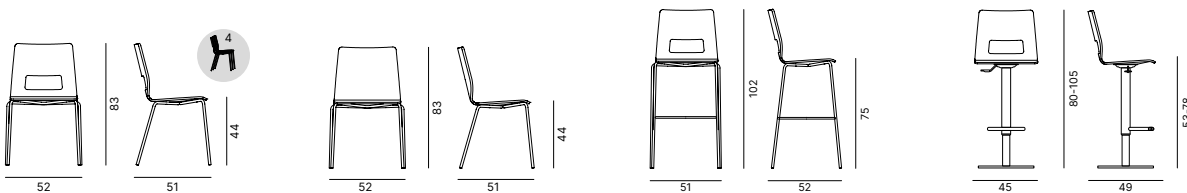
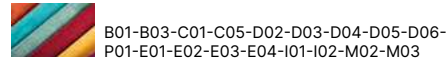

BASE FINISH OPTIONS
FINITURE DISPONIBILI BASE

METAL
METALLO



SHELL FINISH OPTIONS
FINITURE DISPONIBILI SCOCCA

LACQUERED
LACCATO



FABRICS AND LEATHERS
TESSUTI E PELLI

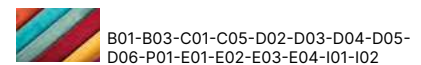

Design Chairs & Soft Seating

CLARK

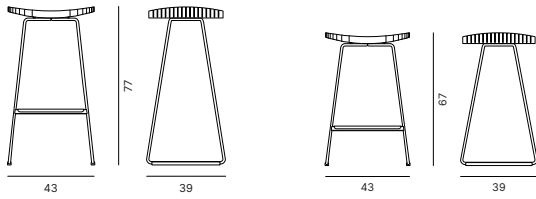

BASE FINISH OPTIONS
FINITURE DISPONIBILI BASE

METAL
METALLO



SEAT FINISH OPTIONS
FINITURE DISPONIBILI SEDILE

SOLID ASH WOOD
FRASSINO MASSELLO



Design Chairs & Soft Seating

C-STOOL

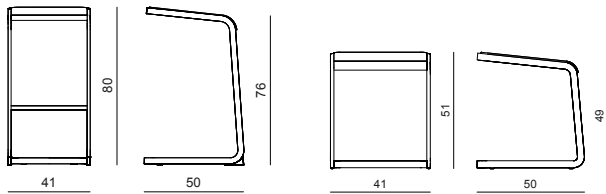

BASE FINISH OPTIONS
FINITURE DISPONIBILI BASE

METAL
METALLO

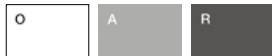

SEAT FINISH OPTIONS
FINITURE DISPONIBILI SEDILE

FABRICS AND LEATHERS
TESSUTI E PELLI



B01-B03-C01-C05-D02-D03-D04-D05-
D06-P01-E01-E02-E03-E04-I01-I02

Design Chairs & Soft Seating

CELL

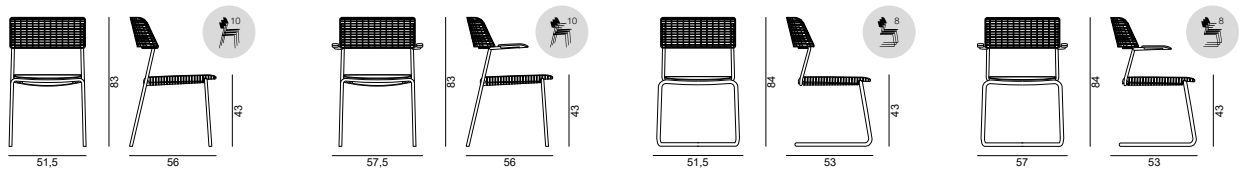

BASE FINISH OPTIONS
FINITURE DISPONIBILI BASE

METAL
METALLO



SEAT AND BACK FINISH OPTIONS
FINITURE DISPONIBILI SEDILE E SCHIENALE

POLYMERS
PLASTICHE



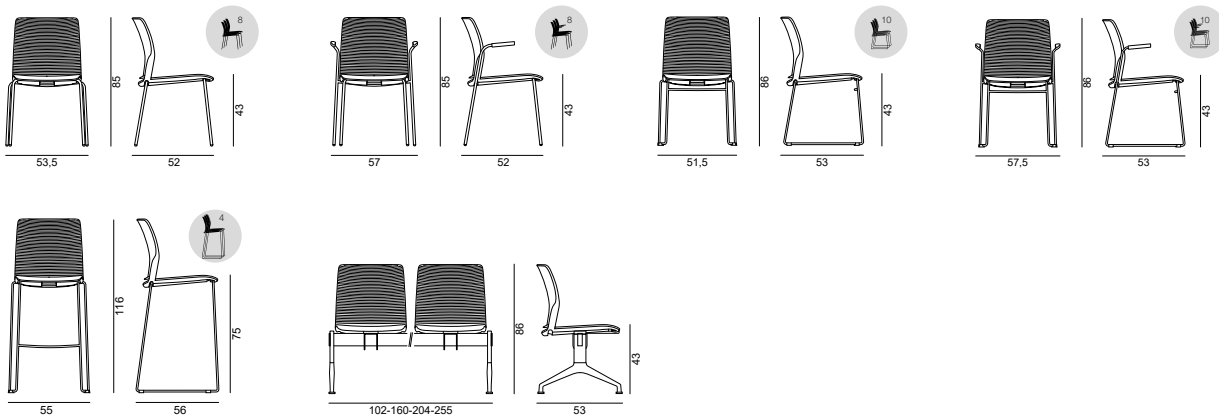

BASE FINISH OPTIONS
FINITURE DISPONIBILI BASE

METAL
METALLO

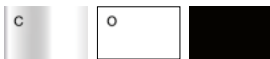

SHELL FINISH OPTIONS
FINITURE DISPONIBILI SCOCCA

POLYMERS
PLASTICHE



SEAT FINISH OPTIONS
FINITURE DISPONIBILI SEDILE

FABRICS AND LEATHERS
TESSUTI E PELLI

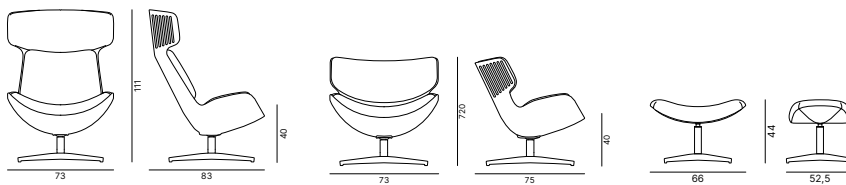
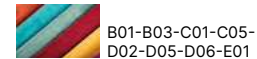

BASE FINISH OPTIONS
FINITURE DISPONIBILI BASE

METAL
METALLO

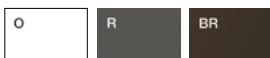

SHELL FINISH OPTIONS
FINITURE DISPONIBILI SCOCCA

POLYMERS
PLASTICHE

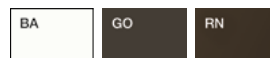

FABRICS AND LEATHERS
TESSUTI E PELLI

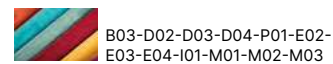

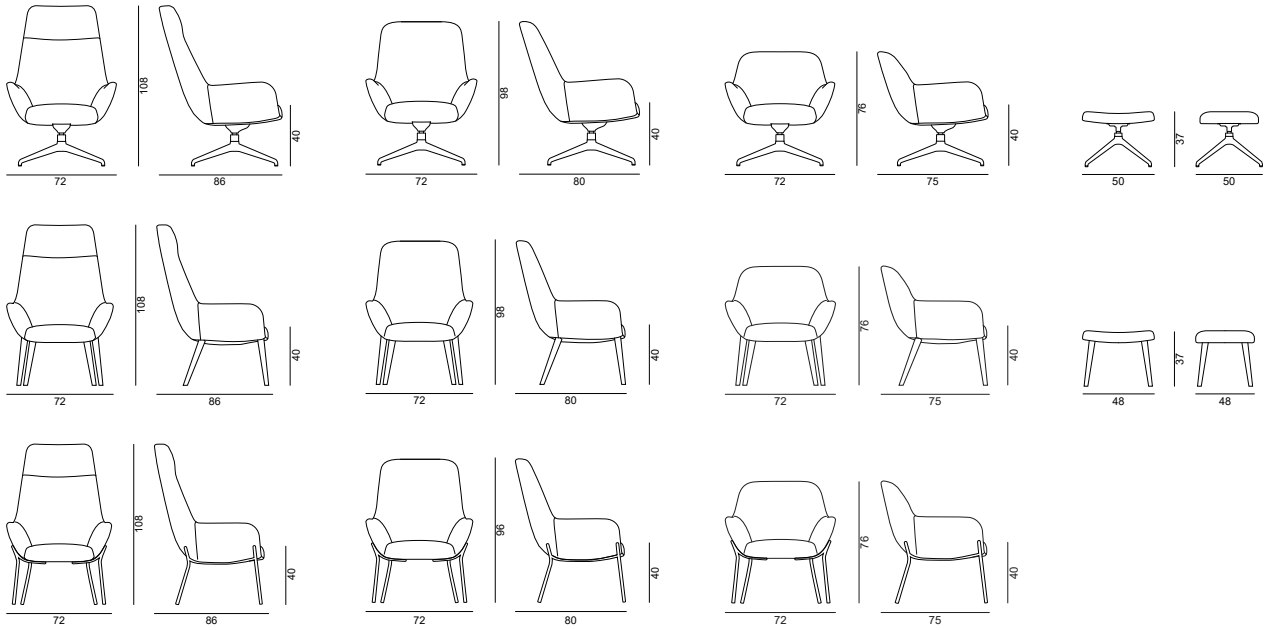

BASE FINISH OPTIONS
FINITURE DISPONIBILI BASE

METAL
METALLO



SOLID ASH WOOD
FRASSINO MASSELLO



UPHOLSTERY
RIVESTIMENTI

FABRICS AND LEATHERS
TESSUTI E PELLI

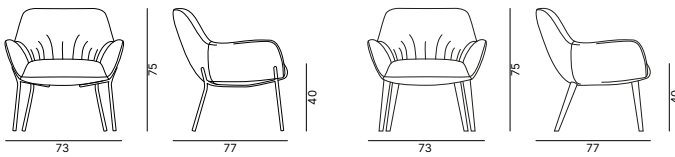
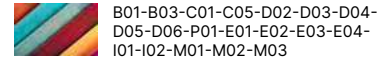

BASE FINISH OPTIONS
FINITURE DISPONIBILI BASE

METAL
METALLO



SOLID ASH WOOD
FRASSINO MASSELLO



UPHOLSTERY
RIVESTIMENTI

FABRICS AND LEATHERS
TESSUTI E PELLI

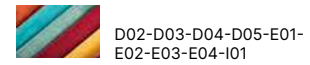

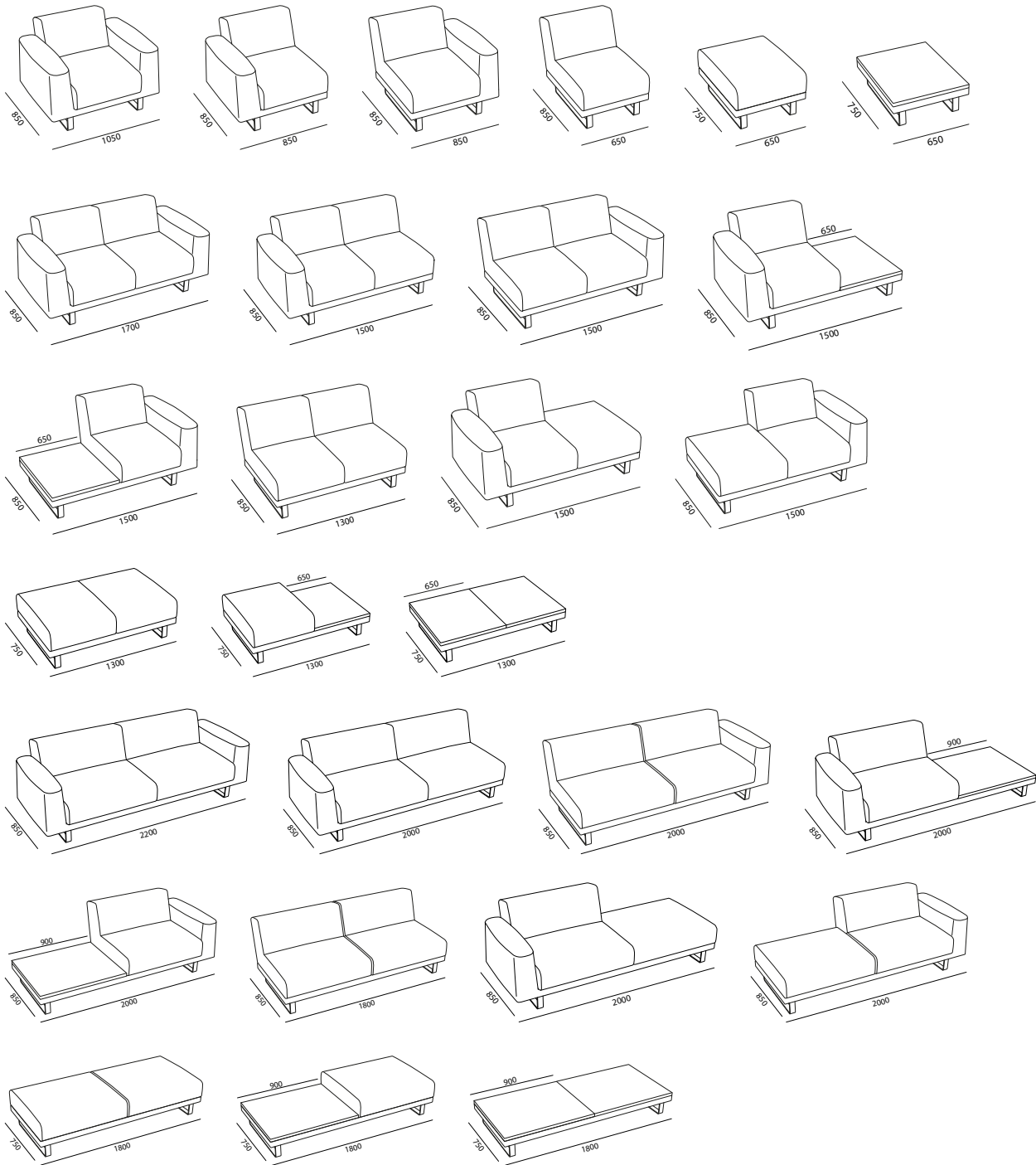

BASE FINISH OPTIONS
FINITURE DISPONIBILI BASE

METAL
METALLO



UPHOLSTERY
RIVESTIMENTI

FABRICS AND LEATHERS
TESSUTI E PELLI



B01-B03-C01-C05-D02-D03-D04-D05-D06-P01-
E01-E02-E03-E04-I01-I02-M01-M02-M03

Design Chairs & Soft Seating

ARCO

Residential & Hospitality Collection

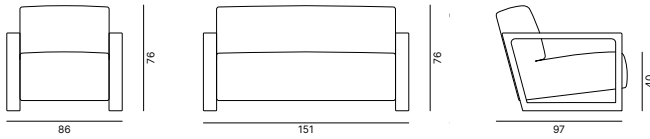

BASE FINISH OPTIONS FINITURE DISPONIBILI BASE

SOLID ASH WOOD
FRASSINO MASSELLO



UPHOLSTERY RIVESTIMENTI

FABRICS AND LEATHERS
TESSUTI E PELLI



B01-B03-C01-C05-D02-D03-D04-D05-D06-P01-
E01-E02-E03-E04-I01-I02-M01-M02-M03

Design Chairs & Soft Seating

ARTE

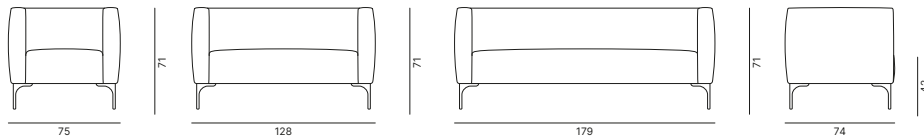

466

LEGS FINISH OPTIONS FINITURE DISPONIBILI PIEDINI

METAL
METALLO



UPHOLSTERY RIVESTIMENTI

FABRICS AND LEATHERS
TESSUTI E PELLI



B01-B03-C01-C05-D02-D03-D04-D05-D06-P01-
E01-E02-E03-E04-I01-I02-M01-M02-M03

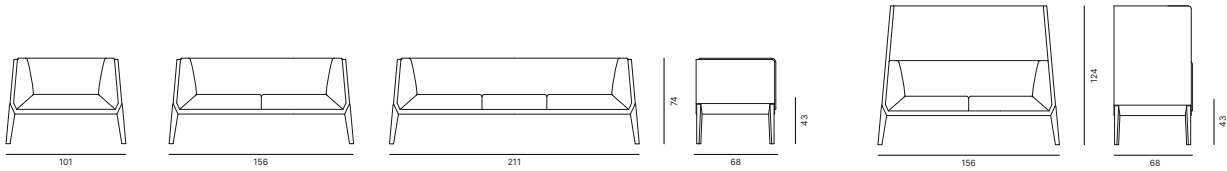

BASE FINISH OPTIONS
FINITURE DISPONIBILI BASE

METAL
METALLO

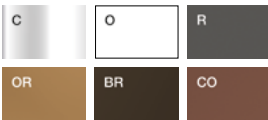

SOLID ASH WOOD
FRASSINO MASSELLO



UPHOLSTERY
RIVESTIMENTI

FABRICS AND LEATHERS
TESSUTI E PELLI



B01-B03-C01-C05-D02-D03-D04-D05-D06-P01-E01-E02-E03-E04-I01-I02-M01-M02-M03

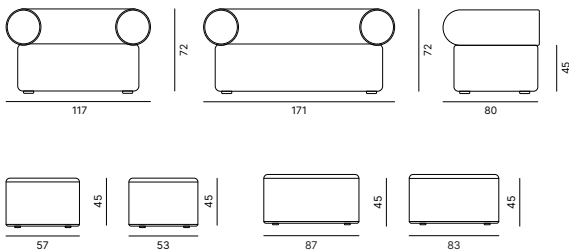

LEGS FINISH OPTIONS
FINITURE DISPONIBILI PIEDINI

SOLID BEECH WOOD
FAGGIO MASSELLO



UPHOLSTERY
RIVESTIMENTI

FABRICS AND LEATHERS
TESSUTI E PELLI



B01-B03-C01-C05-D02-D03-D04-D05-D06-P01-E01-E02-E03-E04-I01-I02-M01-M02-M03

Design Chairs & Soft Seating

ADO

Residential & Hospitality Collection

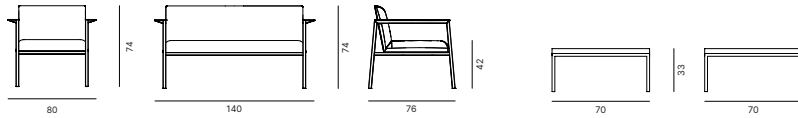

BASE FINISH OPTIONS FINITURE DISPONIBILI BASE

METAL METALLO

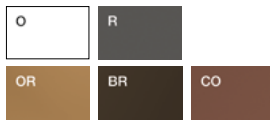

ARMS FINISH OPTIONS FINITURE DISPONIBILI BRACCIOLI

SOLID ASH WOOD FRASSINO MASSELLO



UPHOLSTERY RIVESTIMENTI

FABRICS AND LEATHERS TESSUTI E PELLI



B01-B03-C01-C05-D02-D03-D04-D05-D06-P01-E01-E02-E03-E04-I01-I02-M01-M02-M03

Design Chairs & Soft Seating

ASTRO

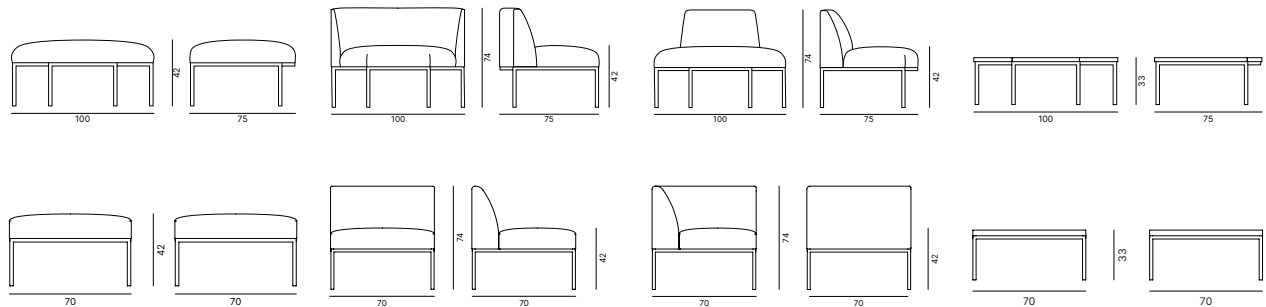

BASE FINISH OPTIONS FINITURE DISPONIBILI BASE

METAL METALLO



UPHOLSTERY RIVESTIMENTI

FABRICS AND LEATHERS TESSUTI E PELLI



B01-B03-C01-C05-D02-D03-D04-D05-D06-P01-E01-E02-E03-E04-I01-I02-M01-M02-M03

Design Chairs & Soft Seating

ARMONY

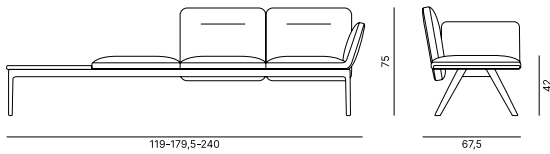

BASE FINISH OPTIONS FINITURE DISPONIBILI BASE

METAL
METALLO



UPHOLSTERY RIVESTIMENTI

FABRICS AND LEATHERS
TESSUTI E PELLI



B01-B03-C05-D02-D03-D04-D05-D06-P01-
E01-E02-E03-E04-I01-I02-M01-M02-M03

Design Chairs & Soft Seating

AGIO

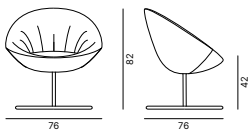

BASE FINISH OPTIONS FINITURE DISPONIBILI BASE

METAL
METALLO



UPHOLSTERY RIVESTIMENTI

FABRICS AND LEATHERS
TESSUTI E PELLI



B01-B03-C01-C05-D02-D03-D04-D05-P01-
E01-E02-E03-E04-I01-I02-M01-M02-M03

Design Chairs & Soft Seating

ALIAS

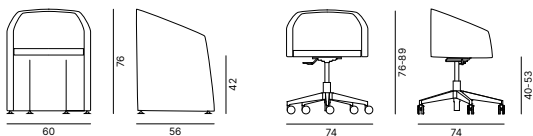

BASE FINISH OPTIONS FINITURE DISPONIBILI BASE

METAL
METALLO



NYLON
NYLON



UPHOLSTERY RIVESTIMENTI

FABRICS AND LEATHERS
TESSUTI E PELLI



B01-B03-C01-C05-D02-D03-D04-D05-D06-
P01-E01-E02-E03

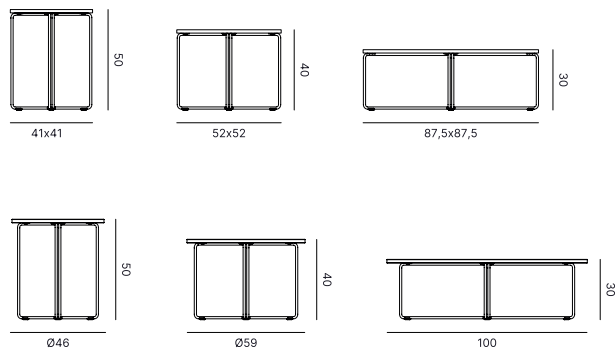

TOP FINISH OPTIONS
FINITURE DISPONIBILI PIANI

PORCELAIN STONWARE
GRES PORCELLANATO



MELAMINE
MELAMINICO

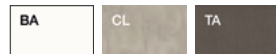

MATT LACQUER
LACCATO OPACO



FRAME FINISH OPTIONS
FINITURE DISPONIBILI STRUTTURA

METAL
METALLO



DECORATIVE EDGES FINISH OPTIONS
FINITURE DISPONIBILI BORDI DECORATIVI

METAL
METALLO

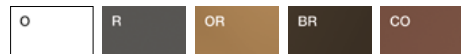

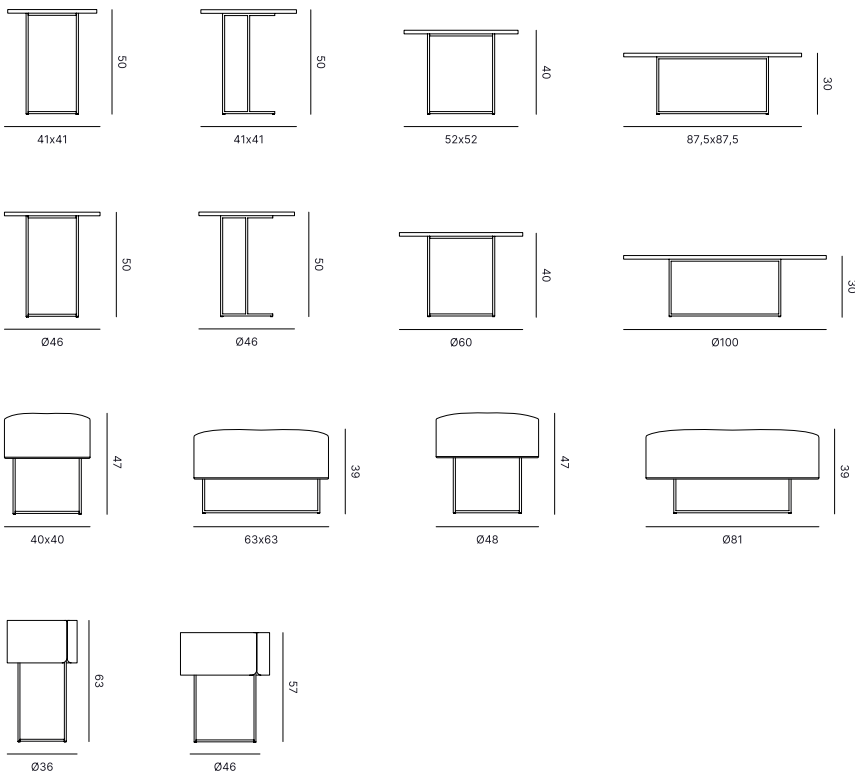

TOP FINISH OPTIONS
FINITURE DISPONIBILI PIANI

PORCELAIN STONEWARE
GRES PORCELLANATO



MELAMINE
MELAMINICO

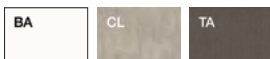

MATT LACQUER
LACCATO OPACO



FRAME FINISH OPTIONS
FINITURE DISPONIBILI STRUTTURA

METAL
METALLO

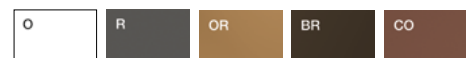

DECORATIVE EDGES FINISH OPTIONS
FINITURE DISPONIBILI BORDI DECORATIVI

METAL
METALLO



POUF UPHOLSTERY
RIVESTIMENTI POUF

FABRICS AND LEATHERS
TESSUTI E PELLI

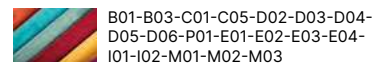

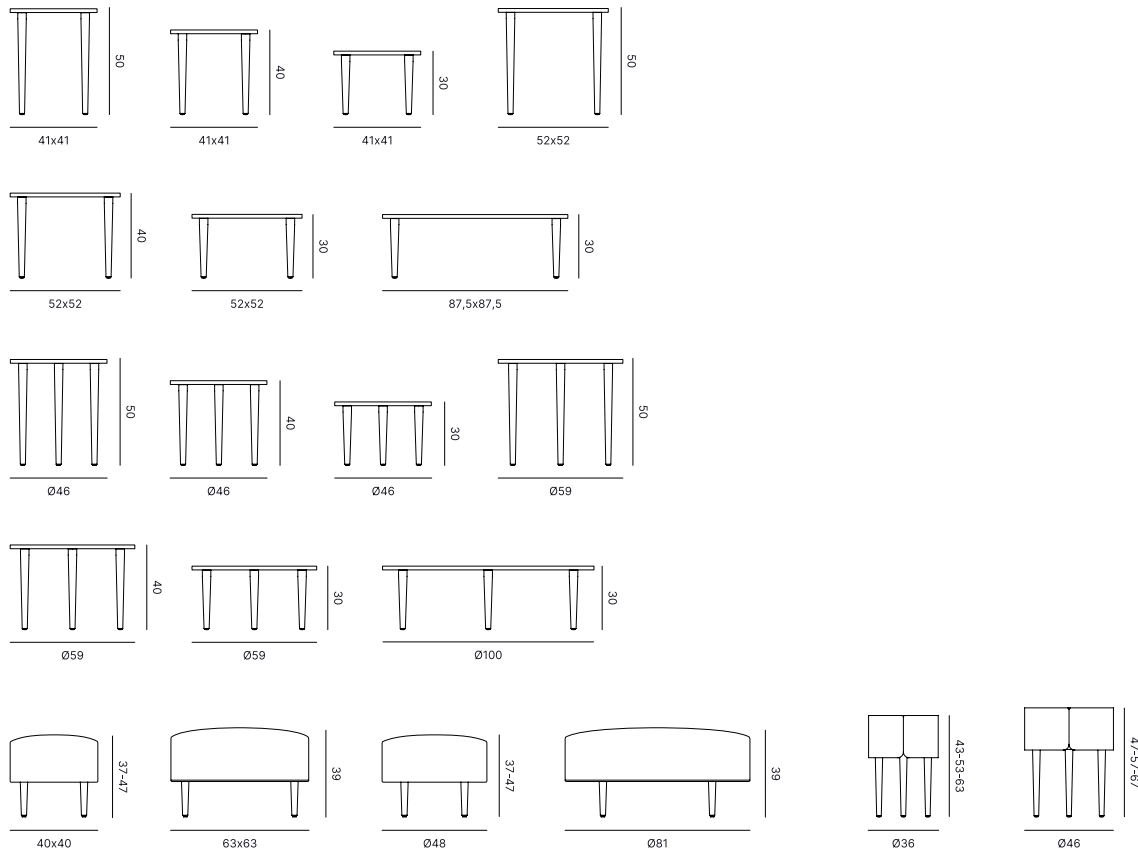

TOP FINISH OPTIONS
FINITURE DISPONIBILI PIANI

PORCELAIN STONEWARE
GRES PORCELLANATO



MELAMINE
MELAMINICO

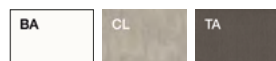

MATT LACQUER
LACCATO OPACO



FRAME FINISH OPTIONS
FINITURE DISPONIBILI STRUTTURA

SOLID ASH WOOD
FRASSINO MASSELLO



472

DECORATIVE EDGES FINISH OPTIONS
FINITURE DISPONIBILI BORDI DECORATIVI

METAL
METALLO

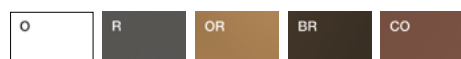

POUF UPHOLSTERY
RIVESTIMENTI POUF

FABRICS AND LEATHERS
TESSUTI E PELLI

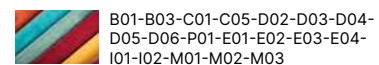

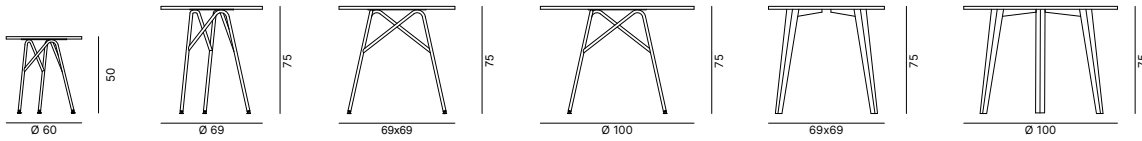

BASE FINISH OPTIONS
FINITURE DISPONIBILI BASE

METAL
METALLO



SOLID ASH WOOD
FRASSINO MASSELLO



TOP FINISH OPTIONS
FINITURE DISPONIBILI PIANI

MELAMINE
MELAMINICO



HPL
HPL



MATT LACQUER
LACCATO OPACO

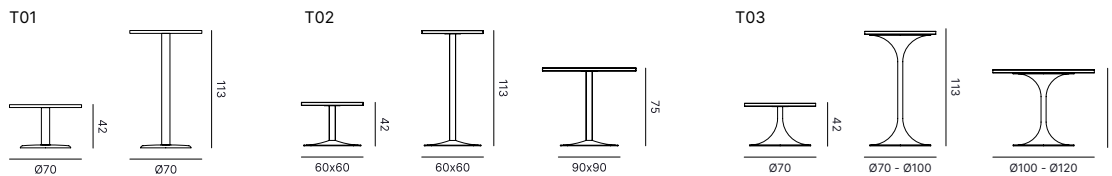

FRAME FINISH OPTIONS
FINITURE DISPONIBILI STRUTTURA

METAL
METALLO

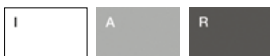

TOP FINISH OPTIONS
FINITURE DISPONIBILI PIANI

MELAMINE
MELAMINICO



MATT LACQUER
LACCATO OPACO



Accessories & Side Tables

T05

Residential & Hospitality Collection

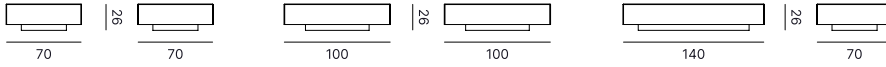

FRAME FINISH OPTIONS
FINITURE DISPONIBILI STRUTTURA

MELAMINE
MELAMINICO

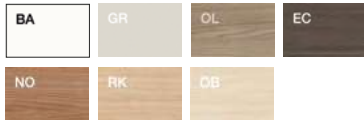

TOP FINISH OPTIONS
FINITURE DISPONIBILI PIANI

MELAMINE
MELAMINICO

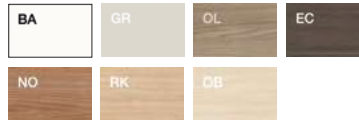

MATT LACQUER
LACCATO OPACO



Accessories & Side Tables

T06

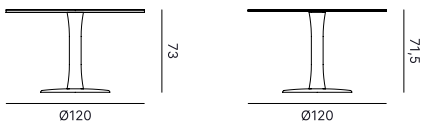

FRAME FINISH OPTIONS
FINITURE DISPONIBILI STRUTTURA

METAL
METALLO



TOP FINISH OPTIONS
FINITURE DISPONIBILI PIANI

MELAMINE
MELAMINICO



MATT LACQUER
LACCATO OPACO



GLASS
VETRO



474

Accessories & Side Tables

FLIPPER

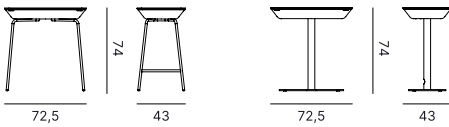

FRAME FINISH OPTIONS
FINITURE DISPONIBILI STRUTTURA

TOP FINISH OPTIONS
FINITURE DISPONIBILI PIANI

METAL
METALLO

MELAMINE
MELAMINICO



Accessories & Side Tables

PETAL & CLOAK

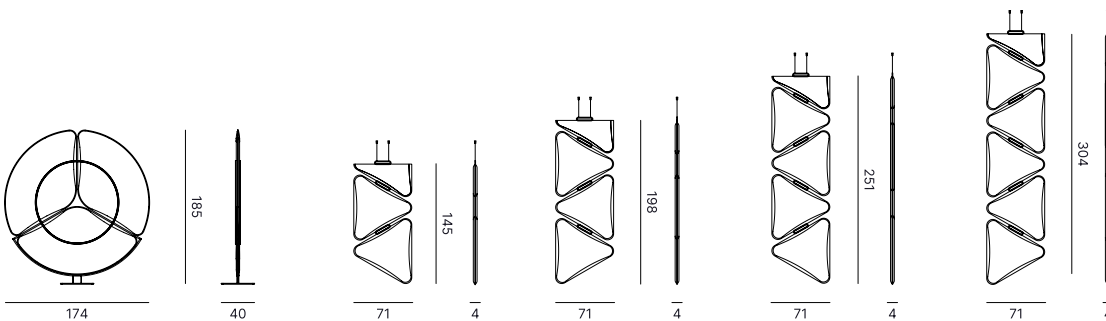

FRAME FINISH OPTIONS
FINITURE DISPONIBILI STRUTTURA

PANELS FINISH OPTIONS
FINITURE DISPONIBILI PANNELLI

METAL
METALLO

FABRICS
TESSUTO

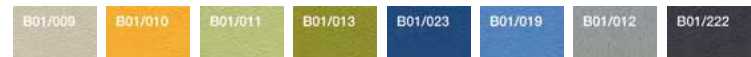

Accessories & Side Tables

ALTER EGO

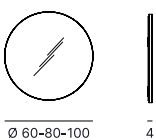

FRAME FINISH OPTIONS
FINITURE DISPONIBILI TELAIO PERIMETRALE

METAL
METALLO



Living Tables

NINE

Residential & Hospitality Collection

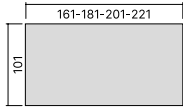

FRAME FINISH OPTIONS FINITURE DISPONIBILI STRUTTURA

METAL METALLO

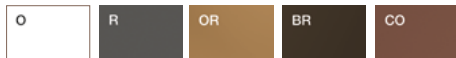

TOPS FINISH OPTIONS FINITURE DISPONIBILI PIANI

WOOD VENEER LEGNO IMPIALLACCIATO



Living Tables

EIGHT

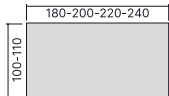

FRAME FINISH OPTIONS FINITURE DISPONIBILI STRUTTURA

METAL METALLO



TOPS FINISH OPTIONS FINITURE DISPONIBILI PIANI

MELAMINE MELAMINICO

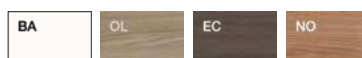

MATT LACQUER LACCATO OPACO



GLASS VETRO



PORCELAIN STONEWARE GRES PORCELLANATO



476

Living Tables

SEVEN

DESIGN LIVING

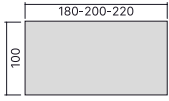

FRAME FINISH OPTIONS FINITURE DISPONIBILI STRUTTURA

METAL METALLO

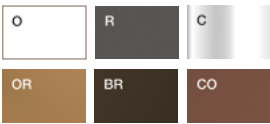

TOPS FINISH OPTIONS FINITURE DISPONIBILI PIANI

MELAMINE MELAMINICO

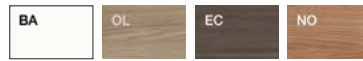

MATT LACQUER LACCATO OPACO



GLASS VETRO



PORCELAIN STONEWARE GRES PORCELLANATO



Living Tables

SIX

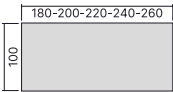

FRAME FINISH OPTIONS FINITURE DISPONIBILI STRUTTURA

METAL METALLO



TOPS FINISH OPTIONS FINITURE DISPONIBILI PIANI

PORCELAIN STONEWARE GRES PORCELLANATO



METAL METALLO

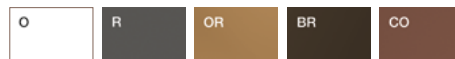

Living Tables

FIVE

Residential & Hospitality Collection

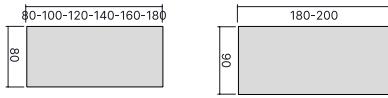

FRAME FINISH OPTIONS FINITURE DISPONIBILI STRUTTURA

METAL METALLO

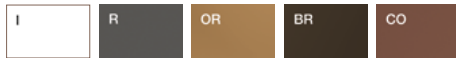

TOPS FINISH OPTIONS FINITURE DISPONIBILI PIANI

MELAMINE MELAMINICO



Living Tables

THREE

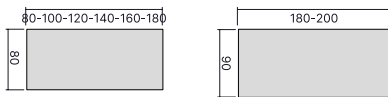

FRAME FINISH OPTIONS FINITURE DISPONIBILI STRUTTURA

METAL METALLO

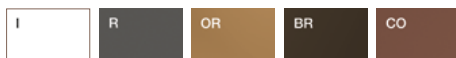

WOOD LEGNO



TOPS FINISH OPTIONS FINITURE DISPONIBILI PIANI

MELAMINE MELAMINICO

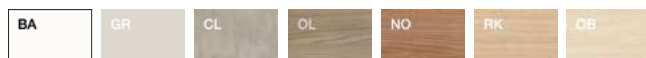

478

Living Tables

TWO

DESIGN LIVING

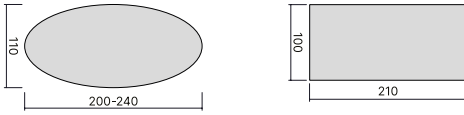

FRAME FINISH OPTIONS
FINITURE DISPONIBILI STRUTTURA

TOPS FINISH OPTIONS
FINITURE DISPONIBILI PIANI

METAL
METALLO

PORCELAIN STONEWARE
GRES PORCELLANATO

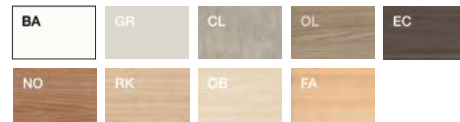
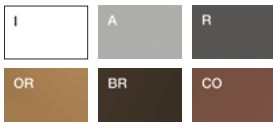

Living Tables

CREO & GREKO



FRAME FINISH OPTIONS
FINITURE DISPONIBILI STRUTTURA

TOPS FINISH OPTIONS
FINITURE DISPONIBILI PIANI

METAL
METALLO

MELAMINE
MELAMINICO

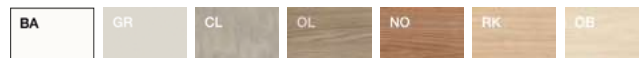
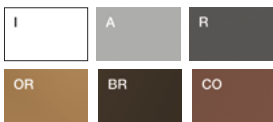

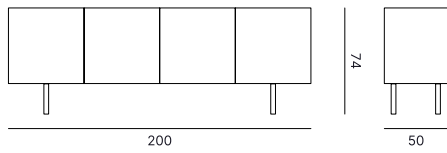
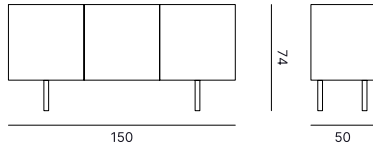

LEGS FINISH OPTIONS
FINITURE DISPONIBILI PIEDINI

METAL
METALLO

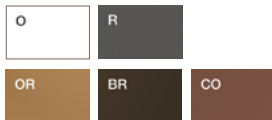

SOLID ASH WOOD
FRASSINO MASSELLO



TOP, SIDES AND DOORS FINISH OPTIONS
FINITURE DISPONIBILI TOP, FIANCHI E ANTE

PORCELAIN STONEWARE
GRES PORCELLANATO



WOOD VENEER
LEGNO IMPIALLACCIATO



MATT LACQUER
LACCATO OPACO



BACK FINISH OPTIONS
FINITURE DISPONIBILI SCHIENA

MELAMINE
MELAMINICO



MATT LACQUER
LACCATO OPACO



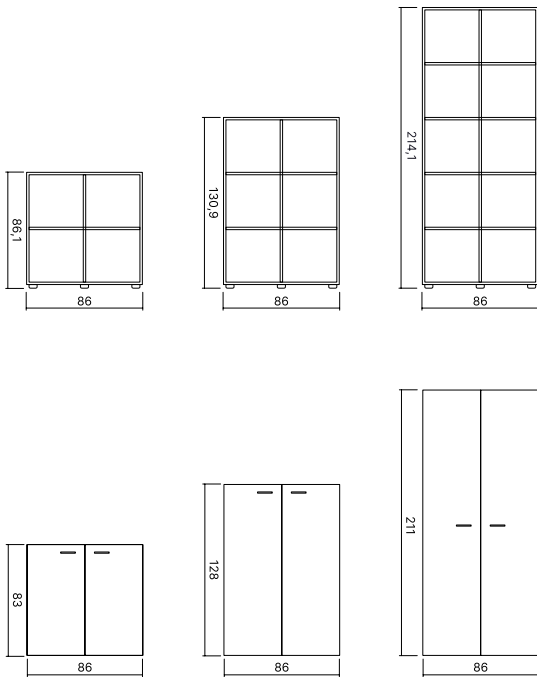

CARCASS FINISH OPTIONS
FINITURE DISPONIBILI SCOCCA

MELAMINE
MELAMINICO



LACQUERED
LACCATO



DOORS, SIDES AND TOP FINISH OPTIONS
FINITURE DISPONIBILI ANTE, FIANCHI E TOP

MELAMINE
MELAMINICO

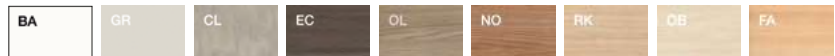

WOOD VENEER
LEGNO IMPIALLACCIATO



LEATHER
CUOINETTO



MATT LACQUER
LACCATO OPACO



Residential & Hospitality Collection

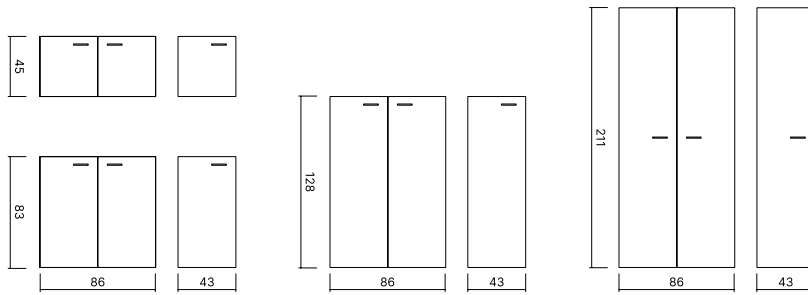
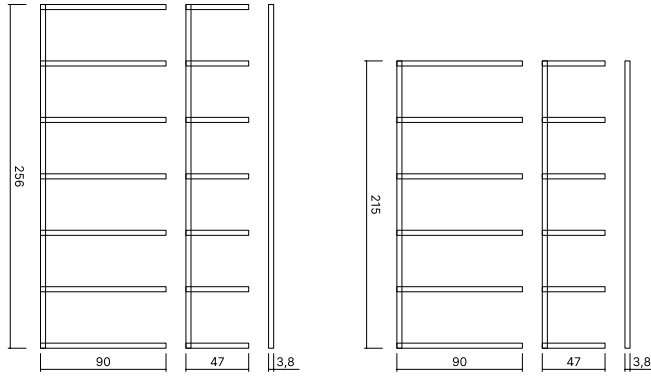

STRUCTURE FINISH OPTIONS
FINITURE STRUTTURA

MELAMINE
MELAMINICO



MATT LACQUER
LACCATO OPACO



DOORS FINISH OPTIONS
FINITURE DISPONIBILI ANTE

MELAMINE
MELAMINICO

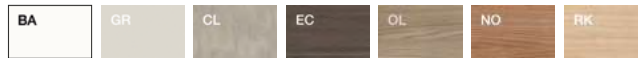

MATT LACQUER
LACCATO OPACO



LEATHER
CUOINETTO



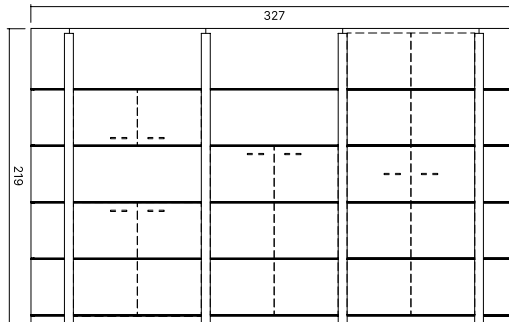
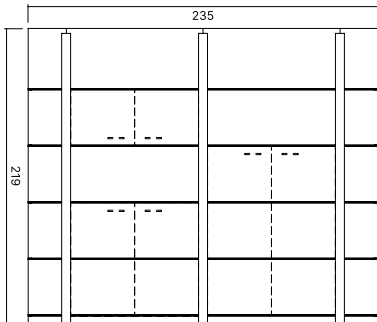
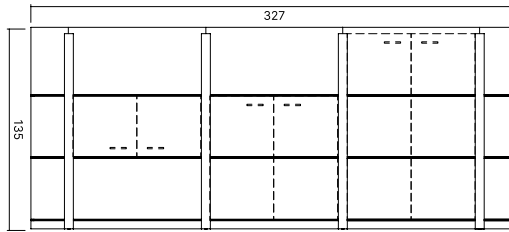
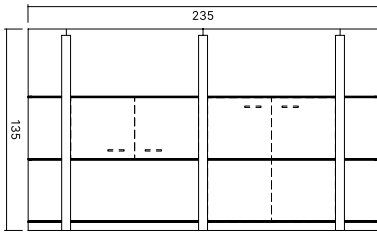

BACK AND SIDE PANEL FINISH OPTIONS
FINITURE SCHIENA E FIANCHI

MELAMINE
MELAMINICO

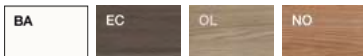

LACQUERED
LACCATO



DOORS FINISH OPTIONS
FINITURE DISPONIBILI ANTE

MELAMINE
MELAMINICO



LACQUERED
LACCATO



LEATHER
CUOINETTO



UPRIGHTS FINISH OPTIONS
FINITURE DISPONIBILI MONTANTI

METAL
METALLO



SHELVES FINISH OPTIONS
FINITURE DISPONIBILI MENSOLE

GLASS
VETRO



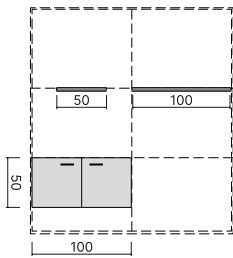
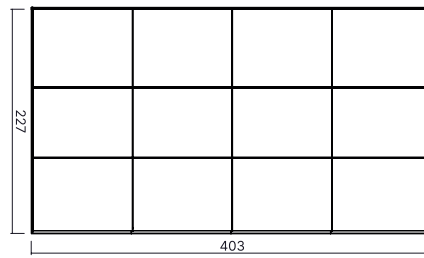
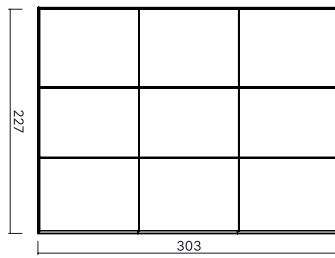
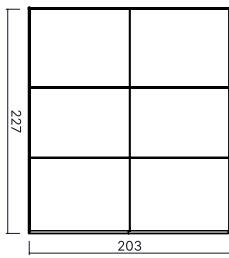

SOLID PANELS FINISH OPTIONS
FINITURE PANNELLI

MELAMINE
MELAMINICO



WOOD VENEER
LEGNO IMPIALLACCIATO



LACQUERED
LACCATO



TRACKS FINISH OPTIONS
FINITURE PROFILI

METAL
METALLO



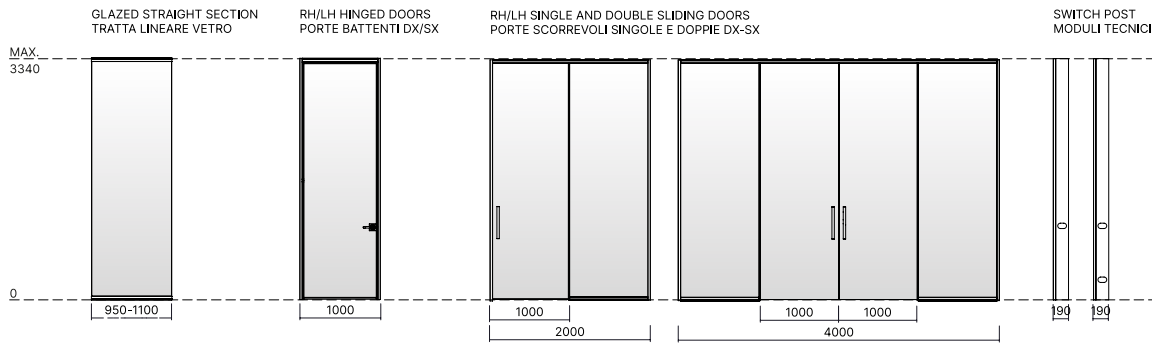

DESIGN LIVING

TRACKS FINISH OPTIONS
FINITURE PROFILI

METAL
METALLO



WOOD VENEER (*)
LEGNO IMPIALLACCIATO (*)



(*) Not available for sliding doors/
Non disponibile per le porte scorrevoli

GLAZED PANELS AND DOORS FINISH OPTIONS
FINITURE MODULI E PORTE VETRO

GLASS
VETRO



GLASS FINISH FILM
PELLICOLE DECORATIVE



Finishes and materials

Materiali e finiture

Residential & Hospitality Collection

B01

On stock



DESIGN LIVING

B03

On stock

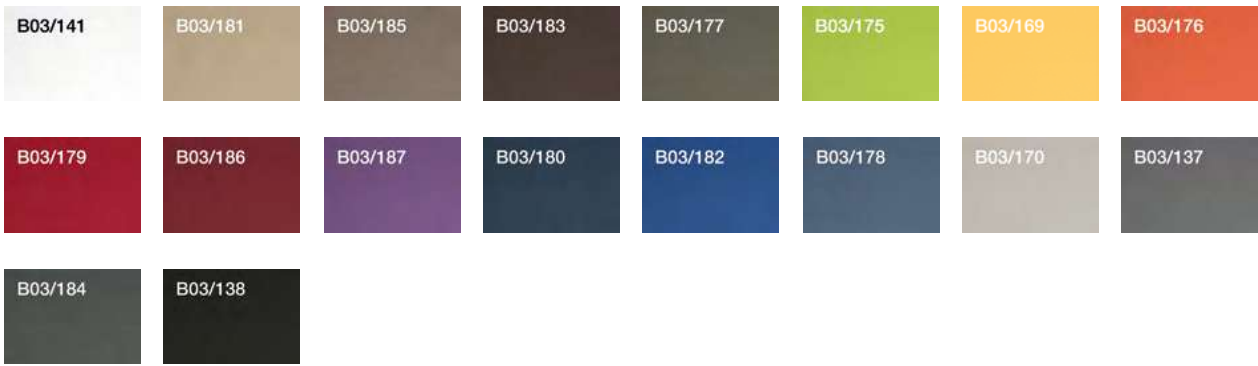

C01

On stock



C05

On stock



D02

On stock

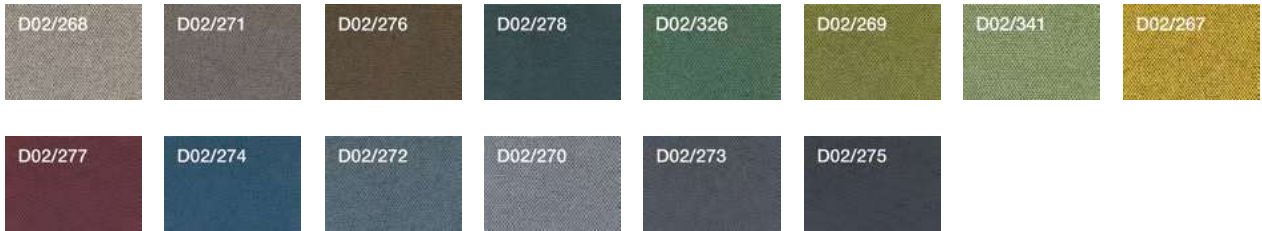

D03

On stock



D04

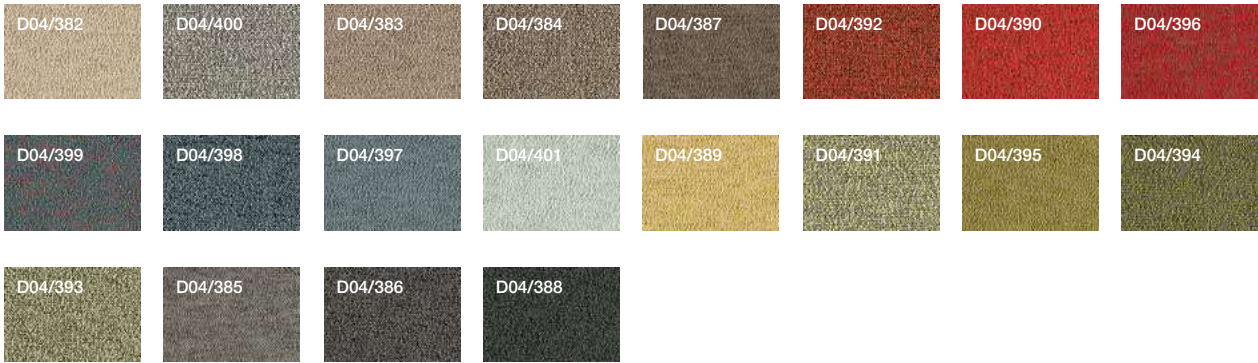

DESIGN LIVING

D05

On stock



D06

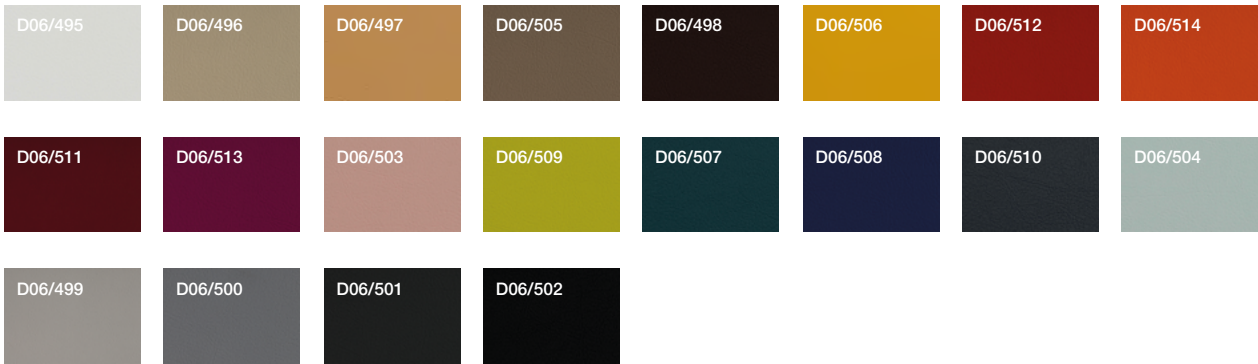

P01

On stock



E01

On stock



E02



E03



DESIGN LIVING

E04

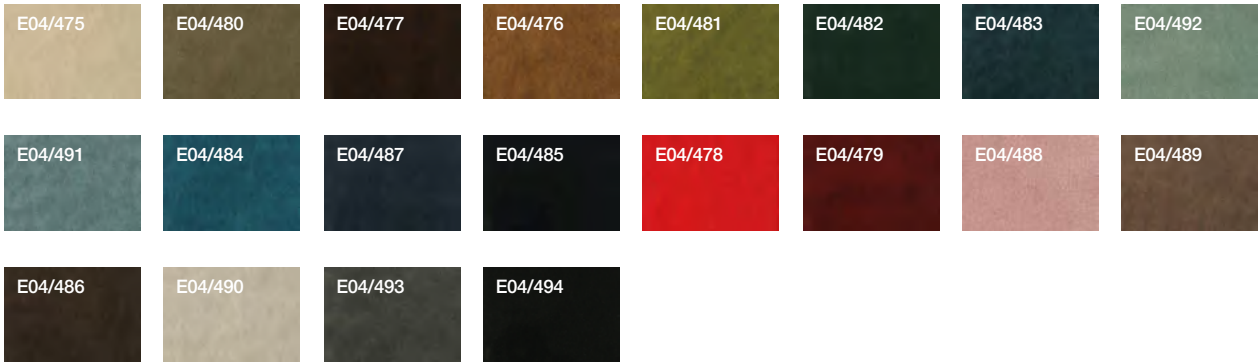

I01



I02

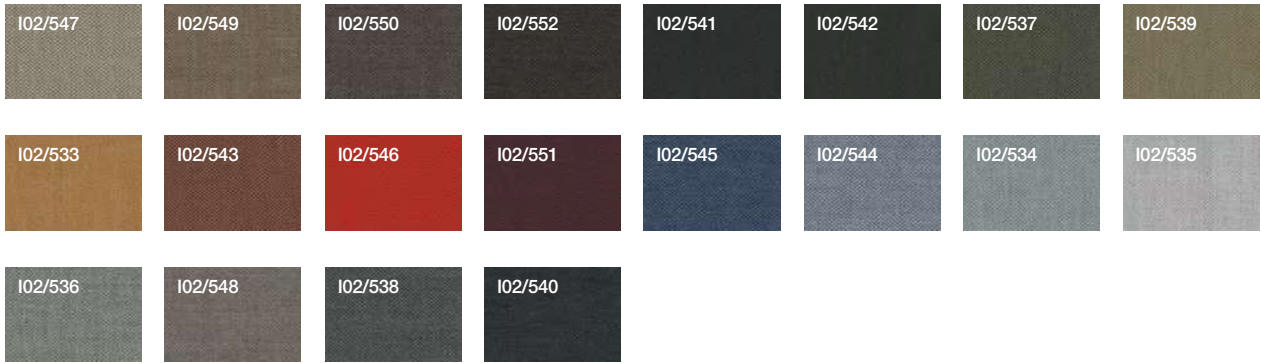

M01



M02

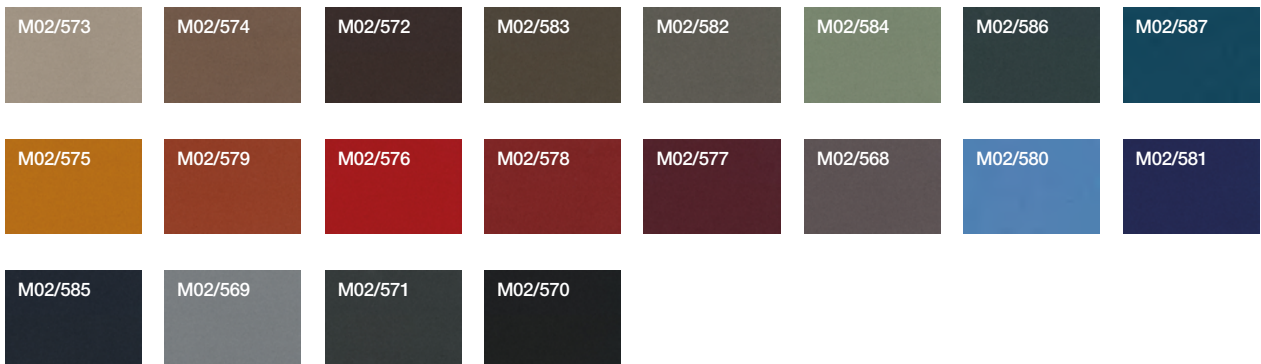

M03



DESIGN LIVING

Polymers

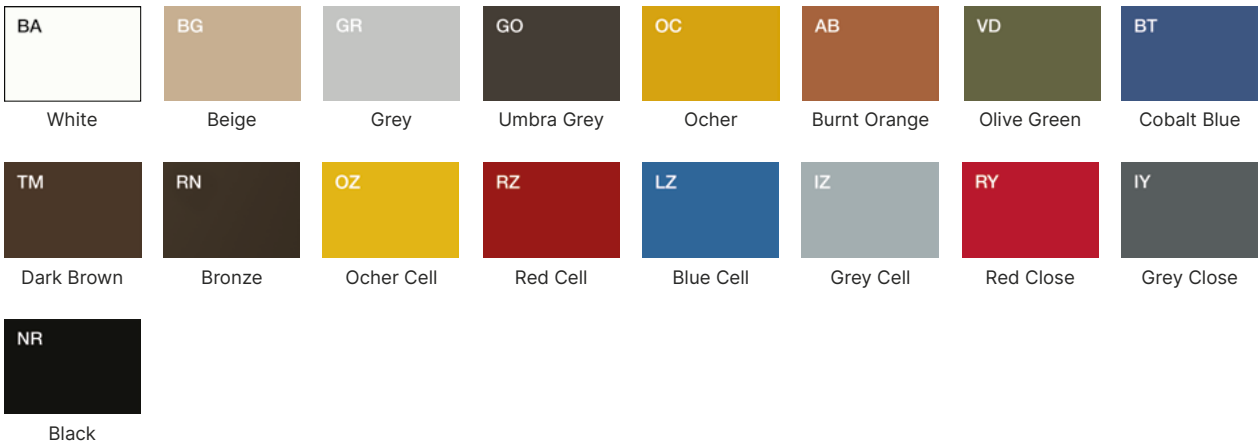

Metal

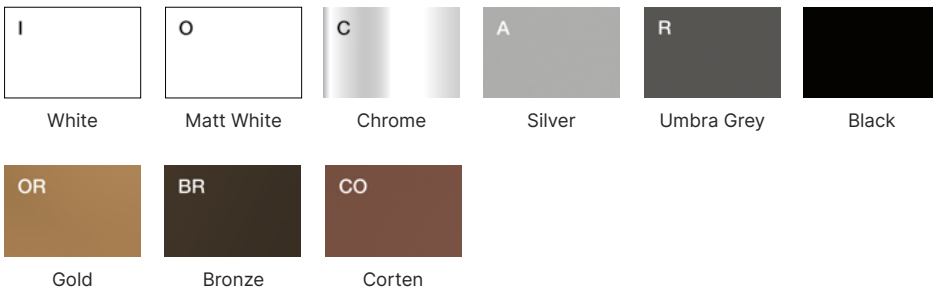

Solid ash wood

				
Oak varnished	Walnut varnished	Elm varnished	Umbre grey varnished	White varnished

Porcelain stoneware

						
Collection Bianco	Fokos Terra	Fokos Piombo	Nero Greco	Invisible White	Emperador Lucido	Noir Desire Lucido

Production lead time: 5 weeks exclusive of delivery time.

Wood veneer

		
Ebony	American Walnut	Elm

Leather







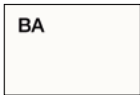

			
Red	Brown	Anthracite	Black

Matt lacquer

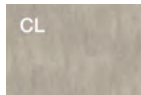
							
White	Grey White	Silk Grey	Light Beige	Beige	Beige Grey	Dark Brown	Ocher
							
Orange	Burnt Orange	Flame Red	Purple Red	Black Red	Sapphire Blue	Cobalt Blue	Pigeon Blue
							
Ocean Blue	Pine Green	Olive Green	Telegrey 4	Grey	Umbra Grey	Traffic Black	

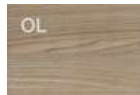
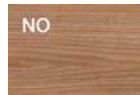
Production lead time: 5 weeks exclusive of delivery time.

Melamine

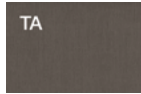
 BA	 GR	 CL	 EC	 OL	 NO	 RK	 OB
White	Grey	Concrete	Eucalyptus	Elm	Canaletto Walnut	Oak	Whitened Elm
 FA	 AA	 TA					
Beech	Silver	Anthracite Linen					

Glass

 TTRASP	 TSATIN	 STRASP	 SSATIN
Toughened Clear	Toughened Frosted	Laminated Clear	Laminated Frosted

Glass finish film

		
Vega	Canvas Champagne Gold	Weave Pearl Dark

Product Design
Quadrifoglio Group R&D Dept.

Project Direction & Coordination
Quadrifoglio Group Marketing & Communication Dept.

Creative Direction
Willy Dalto

Graphic Design
Federica Mattietto

Images
Nudesign, Udine

Color Separation & Print
Sincromia, Pordenone
August 2022

Cod. LIOCRH22

Discover our Designers and Partners



